



This is a digital copy of a book that was preserved for generations on library shelves before it was carefully scanned by Google as part of a project to make the world's books discoverable online.

It has survived long enough for the copyright to expire and the book to enter the public domain. A public domain book is one that was never subject to copyright or whose legal copyright term has expired. Whether a book is in the public domain may vary country to country. Public domain books are our gateways to the past, representing a wealth of history, culture and knowledge that's often difficult to discover.

Marks, notations and other marginalia present in the original volume will appear in this file - a reminder of this book's long journey from the publisher to a library and finally to you.

Usage guidelines

Google is proud to partner with libraries to digitize public domain materials and make them widely accessible. Public domain books belong to the public and we are merely their custodians. Nevertheless, this work is expensive, so in order to keep providing this resource, we have taken steps to prevent abuse by commercial parties, including placing technical restrictions on automated querying.

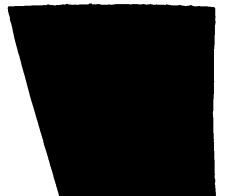
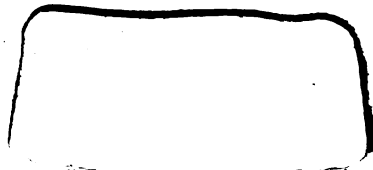
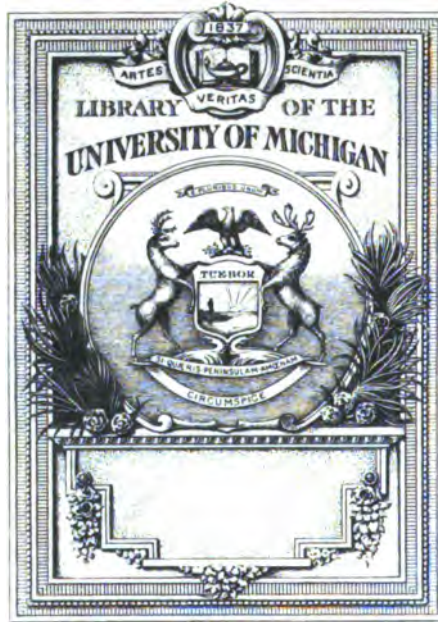
We also ask that you:

- + *Make non-commercial use of the files* We designed Google Book Search for use by individuals, and we request that you use these files for personal, non-commercial purposes.
- + *Refrain from automated querying* Do not send automated queries of any sort to Google's system: If you are conducting research on machine translation, optical character recognition or other areas where access to a large amount of text is helpful, please contact us. We encourage the use of public domain materials for these purposes and may be able to help.
- + *Maintain attribution* The Google "watermark" you see on each file is essential for informing people about this project and helping them find additional materials through Google Book Search. Please do not remove it.
- + *Keep it legal* Whatever your use, remember that you are responsible for ensuring that what you are doing is legal. Do not assume that just because we believe a book is in the public domain for users in the United States, that the work is also in the public domain for users in other countries. Whether a book is still in copyright varies from country to country, and we can't offer guidance on whether any specific use of any specific book is allowed. Please do not assume that a book's appearance in Google Book Search means it can be used in any manner anywhere in the world. Copyright infringement liability can be quite severe.

About Google Book Search

Google's mission is to organize the world's information and to make it universally accessible and useful. Google Book Search helps readers discover the world's books while helping authors and publishers reach new audiences. You can search through the full text of this book on the web at <http://books.google.com/>

16 put



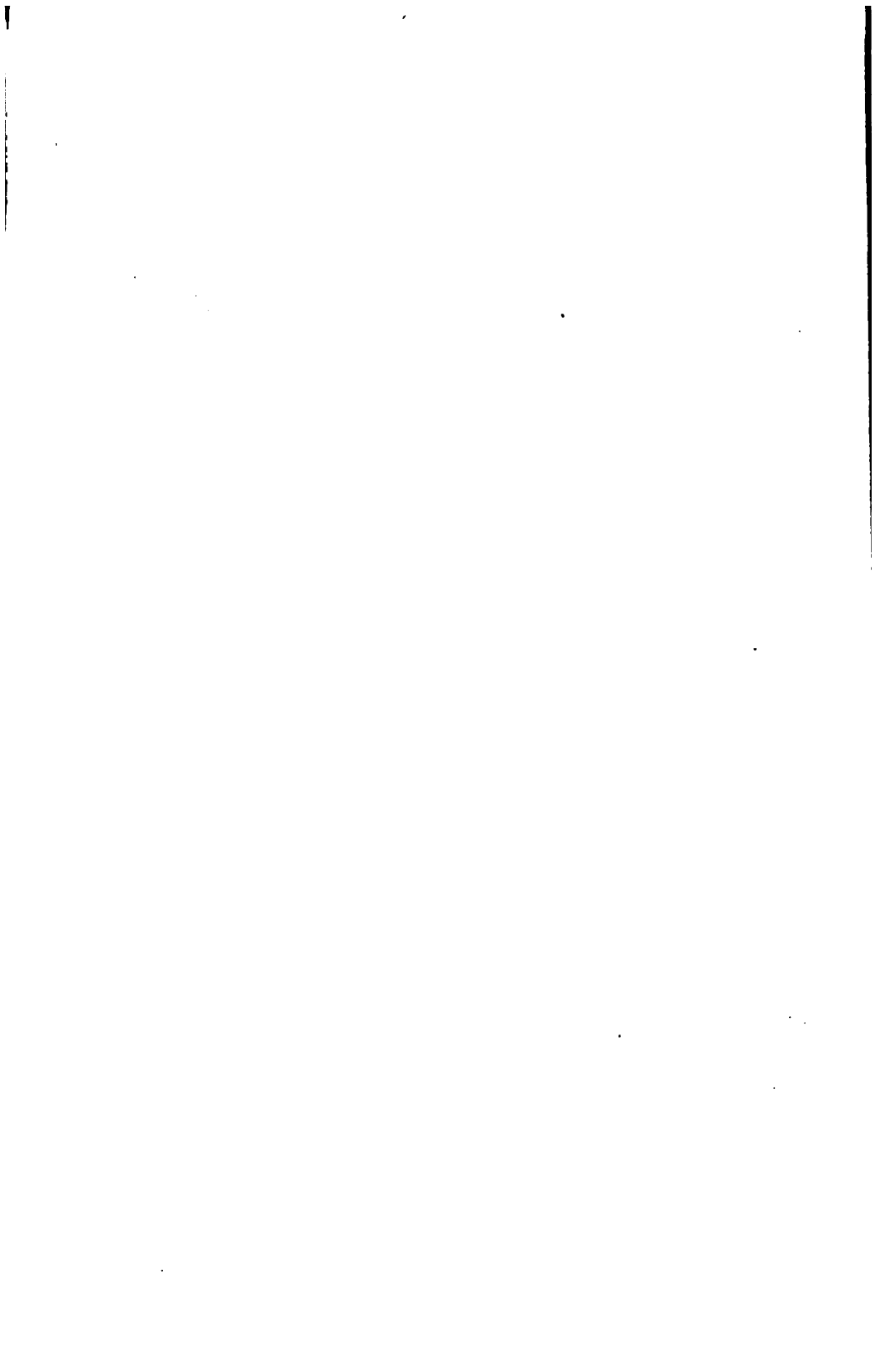
CHEMICAL
LIBRARY

QC

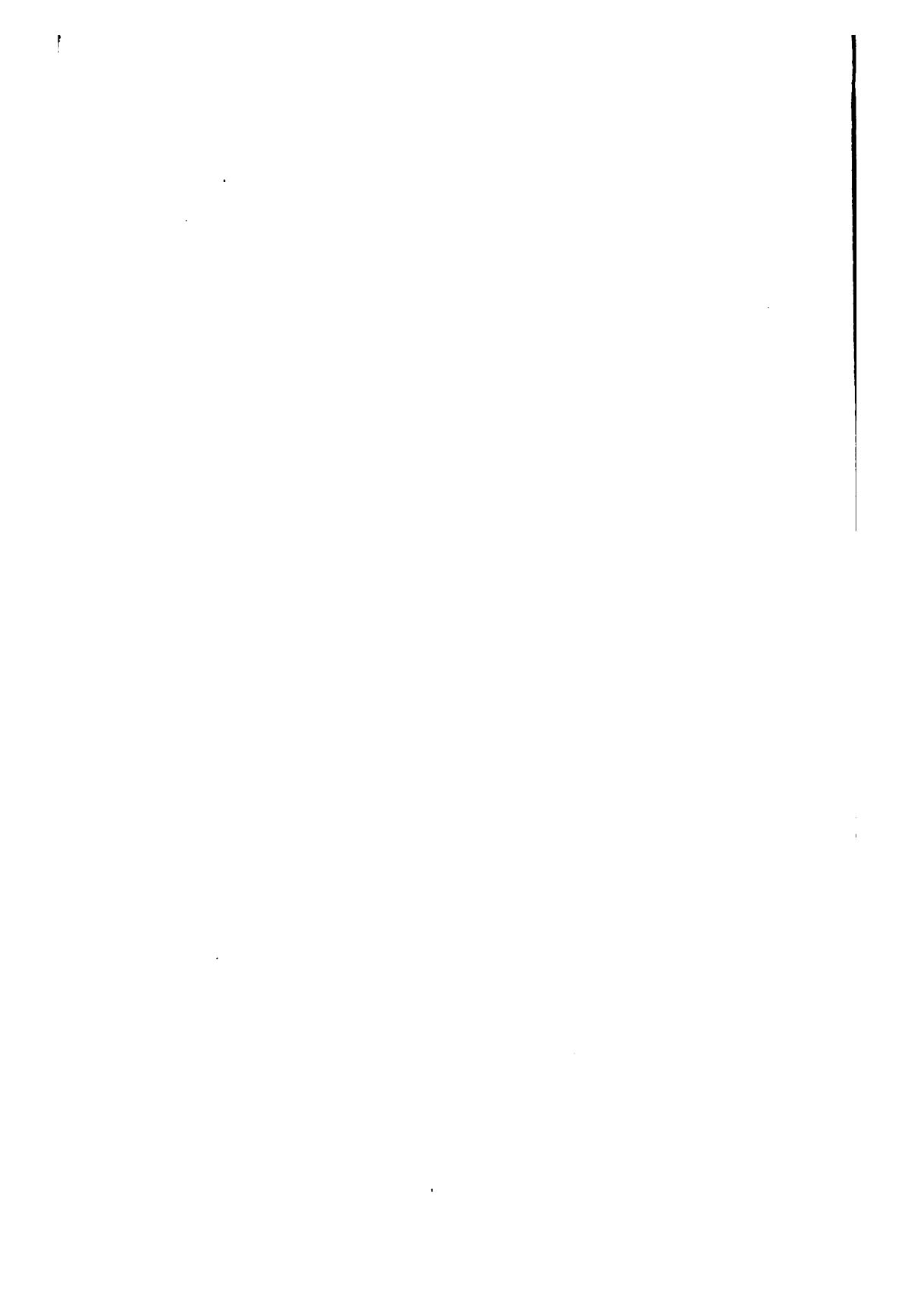
711

T483r

1921







RAYS OF POSITIVE ELECTRICITY
AND THEIR APPLICATION TO
CHEMICAL ANALYSES

1

2

3

RAYS OF POSITIVE ELECTRICITY
AND THEIR APPLICATION TO
CHEMICAL ANALYSES

MONOGRAPHS ON PHYSICS

EDITED BY

SIR J. J. THOMSON, O.M., F.R.S.

MASTER OF TRINITY COLLEGE, CAMBRIDGE

AND

FRANK HORTON, Sc.D.

PROFESSOR OF PHYSICS IN THE UNIVERSITY OF LONDON

8vo.

RAYS OF POSITIVE ELECTRICITY AND THEIR APPLICATION TO CHEMICAL ANALYSIS. By Sir J. J. THOMSON, O.M., F.R.S., Master of Trinity College, Cambridge. With Illustrations.

MODERN SEISMOLOGY. By G. W. WALKER, A.R.C.Sc., M.A., F.R.S., Deputy University Lecturer in Astrophysics in the University of Cambridge. With Plates and Diagrams.

THE SPECTROSCOPY OF THE EXTREME ULTRA-VIOLET. By THEODORE LYMAN, Ph.D., Assistant Professor of Physics, Harvard University. With Diagrams.

THE EMISSION OF ELECTRICITY FROM HOT BODIES. By O. W. RICHARDSON, F.R.S., Wheatstone Professor of Physics, King's College, London. With Diagrams.

RELATIVITY, THE ELECTRON THEORY, AND GRAVITATION. By E. CUNNINGHAM, M.A., Fellow and Lecturer St. John's College, Cambridge. With Diagrams.

THE PHYSICAL PROPERTIES OF COLLOIDAL SOLUTIONS. By E. F. BURTON, B.A., Ph.D., Associate Professor of Physics, University of Toronto. With Illustrations.

LONGMANS, GREEN AND CO.

39 PATERNOSTER ROW, LONDON, E.C. 4

NEW YORK, BOMBAY, CALCUTTA, & MADRAS

**RAY'S OF
POSITIVE ELECTRICITY**
AND THEIR APPLICATION TO
CHEMICAL ANALYSES

BY
SIR J. J. THOMSON, O.M., F.R.S.

MASTER OF TRINITY COLLEGE, CAMBRIDGE
PROFESSOR OF EXPERIMENTAL PHYSICS, CAMBRIDGE

WITH ILLUSTRATIONS

SECOND EDITION

LONGMANS, GREEN AND CO.
39 PATERNOSTER ROW, LONDON
FOURTH AVENUE & 30TH STREET, NEW YORK
BOMBAY, CALCUTTA, AND MADRAS

1921

10

Chemistry
of Matter
1921

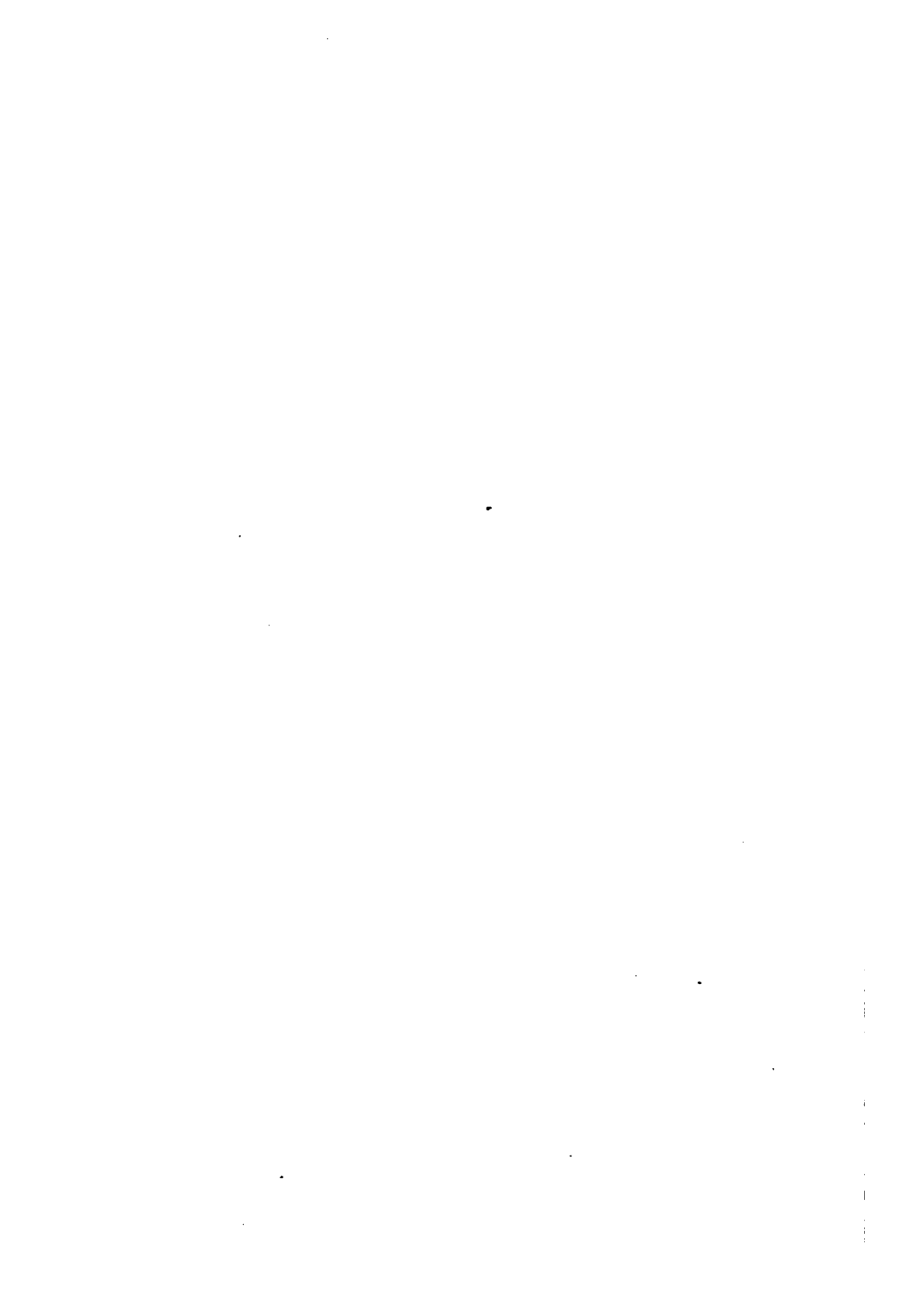
PREFACE TO SECOND EDITION

THIS edition contains a considerable amount of new matter both in the text and in the plates. I have paid special attention to those properties of the Positive Rays which seem to throw light on the problems of the structure of molecules and atoms and the question of chemical combination. The hope expressed in the first edition that the method of Positive Rays would be of service in connection with important chemical problems has been fulfilled to a remarkable extent by the researches of Mr. Aston and others on the determination of atomic weights and the detection of isotopes. I am convinced that as yet we are only at the beginning of a harvest of results which will elucidate the process of chemical combination, and thus bridge over the most serious gap which at present exists between Physics and Chemistry.

I regret the long delay in the issue of this edition; it has been due to the War and the pressure of many duties. I have much pleasure in thanking Mr. W. H. Hayles, of the Cavendish Laboratory, for his help in the preparation of the plates.

J. J. THOMSON.

THE LODGE,
TRINITY COLLEGE, CAMBRIDGE.
August, 1921.



PREFACE TO FIRST EDITION

I HAVE endeavoured in this book to give some account of the experiments on Positive Rays which have been made at the Cavendish Laboratory during the last seven years, and which have been the subject of papers scattered through the Philosophical Magazine, the Proceedings of the Royal Society, and the Proceedings of the Cambridge Philosophical Society. I have, in addition, included a short account of the researches of Stark and others on the Doppler effect in Positive Rays and of Gehrcke and Reichenheim's experiments on Anode Rays, as these, those on the Doppler effect especially, are very closely connected with the results obtained by the very different methods described in the earlier part of this book. I have described at some length the application of Positive Rays to chemical analysis; one of the main reasons for writing this book was the hope that it might induce others, and especially chemists, to try this method of analysis. I feel sure that there are many problems in Chemistry which could be solved with far greater ease by this than by any other method. The method is surprisingly sensitive—more so even than that of Spectrum Analysis, requires an infinitesimal amount of material, and does not require

	PAGE
RETROGRADE RAYS	134
ANODE RAYS	142
DOPPLER EFFECT SHOWN BY POSITIVE RAYS	148
POLARIZATION OF LIGHT FROM POSITIVE RAYS	165
SPECTRA PRODUCED BY BOMBARDMENT WITH POSITIVE RAYS	169
DISINTEGRATION OF METALS UNDER THE ACTION OF POSITIVE RAYS	171
ABSORPTION OF GASES IN THE DISCHARGE TUBE	178
USE OF POSITIVE RAYS FOR CHEMICAL ANALYSIS	179
DISCUSSION OF PHOTOGRAPHS	188
EXAMINATION OF THE GASES GIVEN OUT WHEN SOLIDS ARE BOMBARDED BY CATHODE RAYS	190
NATURE OF X ₃ , THE SUBSTANCE GIVING THE "3" LINE	196
ORIGIN OF THE LINE $m/e = 3.5$	203
CONDENSATION OF GASES ON THE SURFACES OF SOLIDS	207
LINES DUE TO NEON	212
DETERMINATION OF ATOMIC WEIGHTS BY POSITIVE RAYS	216
STRUCTURE OF ATOMS AND MOLECULES	222
INDEX	235

LIST OF PLATES

PLATE I (FIGS. 1, 2, 3, 4)	}	<i>At end of Volume</i>
PLATE II (FIGS. 1, 2, 3, 4)		
PLATE III (FIGS. 1, 2, 3, 4)		
PLATE IV (FIGS. 1, 2, 3, 4)		
PLATE V (FIGS. 1, 2)		
PLATE VI (FIGS. 1, 2, 3, 4)		
PLATE VII (FIGS. 1, 2, 3, 4)		
PLATE VIII (FIGS. 1, 2, 3)		
PLATE IX		

RAYs OF POSITIVE ELECTRICITy

THE positive rays were discovered by Goldstein in 1886.¹ His apparatus is represented in Fig. 1; the cathode K which stretched right across the tube r was a metal plate through which a number of holes were drilled, the diameter of the holes being considerably less than the thickness of the plate; the axes of the holes were at right angles to the surface of the plate; the anode a was at the end of the lower part of the tube. The pressure of the gas in the tube was so low that when the electrodes K and a were connected with the terminals of an induction coil and a discharge passed through the tube, the dark space below the cathode was well developed. Under these circumstances Goldstein found that slightly diverging bundles of a luminous discharge streamed through the holes in the cathode into the upper tube. The colour of the light in these bundles depended on the kind of gas with which the tube was filled: when it was air the light was yellowish, when it was hydrogen, rose colour. These rays can be shown very conveniently by the use of the tube represented in Fig. 2; a form also used by Goldstein in his earlier experiments. The cathode which fills the middle of the tube is a flat disc with a hole in it; a metal tube fitting into the hole is soldered on to the cathode, the length of the tube

¹ Über eine noch nicht untersuchte Strahlungsform an der Kathode inducirter Entladungen. "Berl. Ber.," XXXIX, p. 691, 1886; "Wied. Ann.," 64, p. 38, 1898.

should be several times the diameter of the hole and its axis perpendicular to the plane of the cathode; the anode is a wire fused into the upper part of the tube. When the pressure of the gas is properly adjusted, the positive rays stream through the tube into the lower part of the vessel while



FIG. 1.

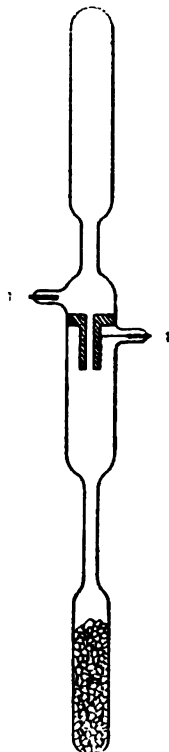


FIG. 2.

the cathode rays shoot upwards. The contrast between the colour of light due to the positive rays and that due to the cathode rays is, when some gases are in the tube, exceedingly striking. Of all the gases I have tried for this purpose neon gives the most striking results, for with this gas the light due

to the positive rays is a most gorgeous red, while that due to the cathode rays is pale blue ; with helium the positive rays give a reddish light, while that due to the cathode rays is green. The spectroscopic examination of the light due to the positive and cathode rays reveals interesting differences which we shall have to consider later ; we may anticipate, however, so far as to say that the character of the light produced by the positive rays is similar to that of the velvety glow which, in an ordinary discharge tube with an unperforated cathode, spreads over the surface of the cathode.

As in Goldstein's experiments these rays were observed streaming through holes or channels in the cathode ; he called them "Kanalstrahlen." Now that they have been proved to be streams of particles, the majority of which are positively electrified, it seems advisable to call them positive rays, as indicating their nature ; the name Kanalstrahlen only suggests the methods of demonstrating them.

Many important properties of the positive rays can be easily demonstrated by the use of a tube like that shown in Fig. 2. For example, when the rays strike against the glass sides of the tube they make the glass phosphoresce. The phosphorescence produced by the positive rays is of a different colour from that produced by the cathode rays and is in general not nearly so bright. With German glass the positive and cathode rays both produce a greenish phosphorescence, though the greens are of different shades. With some substances the contrast is much more striking : for example, with fused lithium chloride the phosphorescence produced by the positive rays is an intense red showing when examined by the spectroscope the red lithium line ; the phosphorescence due to the cathode rays is a light blue giving a continuous spectrum. The phosphorescence due to the positive rays is a most valuable aid for studying the way the rays are deflected

by electric and magnetic forces, and it is important to find the substance which gives the brightest phosphorescence. The substance which I have found most useful is willemite, a natural silicate of zinc. The mineral should be ground into as fine a powder as possible, the powder shaken up in alcohol so as to form a suspension, which is allowed to deposit slowly on a glass plate; by this method the glass is covered with an exceedingly even deposit of the willemite. After continued exposure to the positive rays the brightness of the phosphorescence diminishes and ultimately disappears, so that for the detection of these rays the willemite must be renewed from time to time. Some substances deteriorate more rapidly than others; for example, zinc blende phosphoresces very brightly under the positive rays, but, as far as my experience goes, it deteriorates much more quickly than willemite, so that when the observations have to last for any considerable time the willemite is preferable. Since phosphorescence necessarily involves the transformation of the material from one state to another some decay is inevitable. A more sensitive, and for many purposes more convenient, way of registering the deflection of the positive rays is to take advantage of the fact that, when these rays strike against a photographic plate, they affect the plate at the place of impact and thus a permanent record of the position of the rays can be obtained. The action of the rays on the plate differs from that of light, since they do not use the whole thickness of the film but only a layer close to the surface, so that it does not follow that the most "rapid" photographic plates are the most sensitive to the positive rays. The choice of the most suitable type of plate is a matter of great importance in many investigations. The most sensitive plates for the detection of the positive rays would be those having very thin films containing as much silver as possible. I have tried the old Daguerreotype process

instead of the usual dry plate method, but without much success. Schumann plates (Baly's "Spectroscopy," p. 359) which are now in commerce are the most sensitive, but for general use I have found Paget process plates the most useful, they are sensitive and give well-contrasted photographs. The plates known as "Imperial Sovereign" also give very good results.

The positive rays gradually remove any thin deposit of metal which may be on the parts of the tube against which they strike. Such thin deposits can readily be produced by running an electric discharge through the tube when it contains gas at a low pressure, using for the cathode a piece of the metal it is wished to deposit on the glass. The metal cathode "splutters" and the metal is deposited as a thin layer on the glass near the cathode.

RECTILINEAR PROPAGATION OF THE POSITIVE RAYS

This can be shown by placing a solid obstacle in the path of a pencil of positive rays: this casts a shadow on the part of the tube which was phosphorescing under the impact of these rays. Comparing the shape of the shadow with that of the obstacle, it is found that the shadow is very approximately the projection of the outside of the solid on the walls of the tube by lines passing through the hole in the cathode through which the pencil of positive rays emerges.

DOUBLE AND HOLLOW CATHODES

Goldstein¹ found that positive rays came freely from the space between two parallel plates metallically connected together and used as a cathode for the discharge through gas at a low pressure. The streams of positive rays are accom-

¹ Goldstein, "Phil. Mag.," VI, p. 372, 1908.

panied by cathode rays, and the discharge from a "sandwich" cathode of this kind, through a gas where there is a marked difference in colour between the luminosity produced by the cathode and positive rays, presents some very interesting features. Hydrogen, and to a still greater degree helium and neon, are suitable gases for this purpose. When a cathode formed of two parallel equilateral triangles connected together by a wire is used for the discharge through helium at a low pressure, the discharge near the cathode has the appearance represented in Fig. 3. From the points of the triangle stream

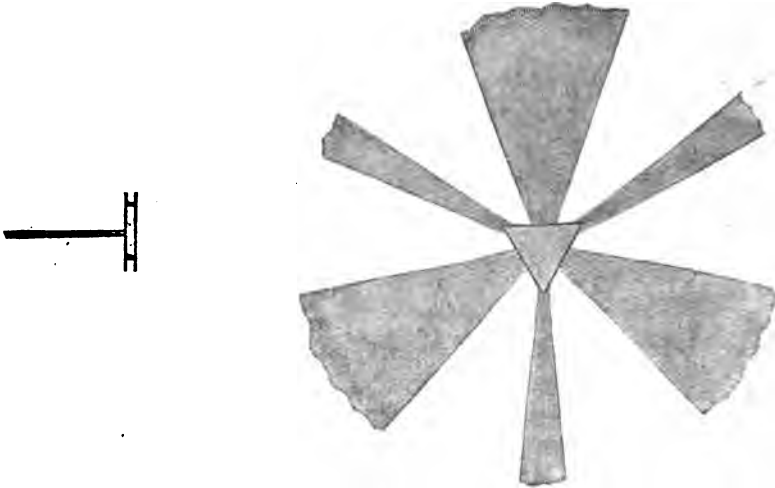


FIG. 3.

pencils of luminosity showing the characteristic red colour of the positive rays in helium, while the middle points of the sides are the origin of streams of greenish luminosity, the colour of the path of the cathode rays through helium. The difference in the character of the rays is also made evident by bringing a small magnet near the discharge tube; the green rays are visibly deflected by the magnet but no appreciable effect is produced on the red rays. By using polygons instead

of triangles, or scalene triangles instead of equilateral ones very interesting distributions of the red and green pencils can be obtained. Researches on these parallel cathodes have been made by Kunz¹ and Orange,² and they are often useful for giving strong pencils of positive rays in definite directions.

Goldstein also found that positive rays come out freely along the axes of hollow tubes when these are used as cathodes. Thus if a hollow cylindrical tube of circular cross section is used as a cathode the stream of rays when the planes of the ends are at right angles to the axis is along the axis. When the plane of one end is oblique to the axis there are two streams at right angles respectively to the cross sections as in Fig. 4. The directions of these streams do not depend on the position of the anode.

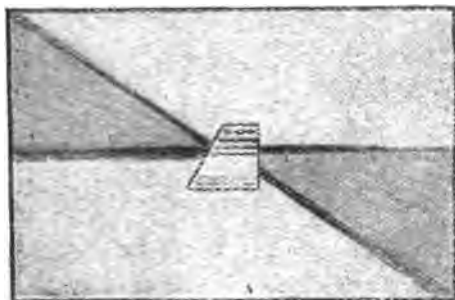


FIG. 4.

When the cross section of the tube is not circular but polygonal very interesting phosphorescent figures are produced by the rays coming from the tube. That represented in Fig. 5 was obtained by Kunz with a tube whose cross section was an equilateral triangle.

¹ Kunz, "Phil. Mag.," VI, xvi, p. 161, 1908.

² Orange, "Proc. Camb. Phil. Soc.," XV, p. 217.

Goldstein ("Phys. Zeitschrift," II, p. 873) has shown that positive rays can be produced in a very simple way by using

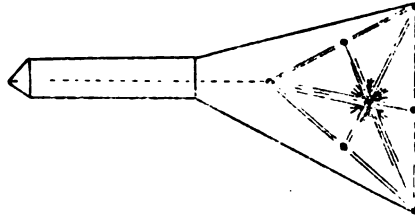


FIG. 5.

two parallel wires as a cathode. The rays spread out from the space between the wires in the manner illustrated in Fig. 6. By using three or more such parallel wires for the cathode very interesting patterns of positive rays can be obtained.

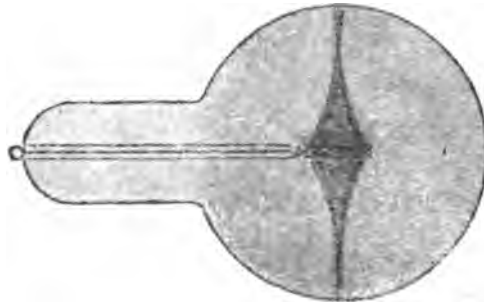


FIG. 6.

Since perforated cathodes of one form or another are used in the great majority of experiments on positive rays, the consideration of the action of these cathodes is a matter of considerable interest and importance. The positive rays passing through a hole in a plane cathode are not by any means identical with those which would have struck the site occupied by the hole had the cathode been continuous.

The hole in the cathode produces a much greater effect when an electric discharge is passing between the anode and cathode than it does on the distribution of the lines of electric force before the discharge begins to pass. There are many points of interest in the behaviour of perforated cathodes which are I think probably connected with the question of the transmission of the electric charge from a positively charged atom or molecule to a metallic electrode.

Thus, for example, Aston ("Proc. Roy. Soc.," 87, A., p. 437) found that when a piece of perforated zinc was used for the cathode the discharge passed more easily than with a continuous zinc cathode of the same area; and also that with the perforated cathode the luminosity in the gas was greater opposite the holes than opposite the zinc.

The path of the cathode rays has considerable influence on the luminosity in the gas and on the ease with which the discharge passes through the tube.

In an experiment made long ago by Sir William Crookes with a tube like that represented in Fig. 7, the discharge went more easily along the path (1) where the cathode rays do not traverse the same path as the positive column than along (2) where the paths coincide. Again, when the discharge is passing along a tube like (2), if the cathode rays are deflected to one side by a magnet, the luminosity of the positive column will come much closer up to the cathode, the Faraday dark space is shortened, and when the magnetic force at the cathode is strong the cathode fall of potential is reduced. The Faraday dark space has its origin in a slight ionization due to cathode rays which have

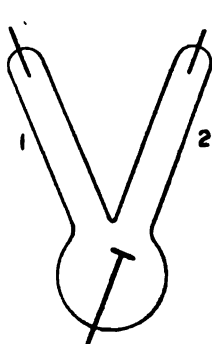


FIG. 7.

travelled through the negative glow, hence if the rays are deflected the Faraday dark space will disappear.

The magnet will deflect the cathode rays when close to the cathode and make them travel along curved paths instead of straight lines ; thus in passing from the cathode to a point in the gas they will travel along a longer path and therefore produce more ions when the magnet is "on" than when it is "off." The magnet produces a virtual increase in the ionizing power of cathode rays close to the cathode ; such an increase will be accompanied by a decrease in the cathode fall of potential.

If the cathode particles started from the inside of a Sandwich cathode their paths would not be straight lines, for an electron shot from the inner surface of one plate would be sent back by the other, and thus would pursue a zigzag path before getting out from between the plates. This increase in the length of path would tend to diminish the cathode fall of potential.

When a positive atom gives up its charge to a metal, it must, when close to the metal, regain an electron and become neutral. If it comes close to a piece of metal at a place where there is no electric force, then an electron in the neighbourhood would run into the atom and might become attached to it. If, however, there is an intense electric field close to the metal the electron will acquire a high velocity and instead of combining with the positive atom may shoot past it. We see from this that the discharge of positive electricity to the electrode may be hampered by a strong electric field, such as might be produced by a double layer of electricity, close to the electrode. Now, when the electrode is emitting cathode rays there is at the seat of emission such a double layer, which not only gives rise to an intense electric field close to the cathode but also diminishes the electric field

in the gas beyond the double layer. The layer does two things: (a) it makes it more difficult for the positive ions to lose their charges: (b) it concentrates the electric field close to the cathode. When this concentration is great the positive ions will acquire by far the larger part of their energy close to the surface of the cathode, and thus ions originating in different parts of the dark space in front of the cathode would reach the surface of the cathode with practically the same energy. Again, the cathode rays which originated in the dark space would only possess a very small fraction of the energy of those which started from the cathode itself. The cathode rays would thus consist of two groups—the energy in one group being constant while that in the other would be variable but small compared with the energy of those in the first group. This is consistent with the behaviour of the cathode rays coming from a continuous cathode. The positive rays coming through a perforated cathode show a wider variation in energy than is indicated by these considerations.

Though a hollow or "sandwich" cathode may be surrounded by the Crookes dark space there is in general luminosity inside the hollow or between the plates, indicating that in these regions there is, what there is not in the dark spaces, recombination of ions or the neutralization of positive particles by electrons. We might also expect that there would be an accumulation of electrons between the plates, for electrons shot out from the inner surface of one plate would be stopped by the other plate. This accumulation of electrons would tend to neutralize the drop of potential which occurs at the surface of the plate and would make the potential in the space between the plates approach that of the metal part of the cathode. Thus we may regard the space between the plates as a cathode without a sudden cathode

drop of potential, or at any rate with a much smaller drop than a metallic cathode. This cathode has also a plentiful supply of electrons behind it to neutralize the positive particles which come up to it. Since the potential drop is much less abrupt, the electric field outside will be more intense than that near a metallic cathode. As the space between the plates is narrow, the gaseous cathode will be small and the electric force will diminish rapidly as we recede from it; the region of intense electric force will extend to a distance from the cathode comparable with the diameter of the hole in the cathode. Ions produced at different places along these lines of force would reach the cathode with different amounts of kinetic energy so that there might be a considerable variation in the velocity of the positive rays coming through the channel; this, as we shall see, is a conspicuous feature in the behaviour of positive rays.

This variation in the velocity of the positive rays should be accompanied by an associated variation in the velocity of those cathode rays which are produced along the paths of those lines of electric force which start from the channels, so that we might expect these cathode rays to be much more heterogeneous than those of the usual type. To test this point I tried the following experiment—

The cathode was a perforated one of the kind used for the production of positive rays. The cathode rays after passing through a fine tube fell upon a screen covered with willemite. At very low pressures the image on the screen was a bright spot at the place where the axis of the tube struck the screen. The spot was surrounded by a bright circle. If the cathode rays varied considerably in velocity they would, if acted upon by a magnet, be deflected by different amounts and the spot would be drawn out into a line. It was found that under the action of the magnet the luminosity had the following appearance. There was a bright spot not markedly larger than the

undeflected one, and this was accompanied by a faint tail where the deflection was greater ; this tail was due to cathode rays which are slower than those producing the bright spot. The tail was so much fainter than the head that it was evident that by far the greater part of these rays possessed the maximum velocity, and that though there were some with smaller velocities these formed but a small fraction of the whole group. We shall see that when the positive rays are deflected by a magnet a spot of luminosity produced by them is in general drawn out into a line of approximately uniform luminosity, proving that the concentration of the positive rays on any particular velocity is much less marked than that of the cathode rays which give rise to phosphorescence on the screen.

We conclude from this experiment that the majority of the fast cathode rays are produced quite close to the cathode and, therefore, experience the full fall of potential. The cathode rays starting from the metal itself need not be accompanied by any equivalent of positively charged particles in the gas. Those originating in the dark space would have a positive particle corresponding to each cathode ray. Ionization in the negative glow would give rise to positive rays which would have experienced the full fall of potential when they reached the cathode, and since the electric field beyond the negative glow is so weak the cathode rays due to this ionization would have so little energy that they would probably escape observation.

Two causes for the emission of cathode rays from the cathode itself suggest themselves. The first of those is the impact of positively charged particles against the cathode. We know by direct experiment (Füchtbauer, " *Ann. der Phys.*," 23, p. 301, 1907 ; Saxen, " *Ann. der Phys.*," 38, p. 319, 1912 ; Baerwald, " *Ann. der Phys.*," 41, p. 643, 1913 ; 42, p. 1207, 1913) that electrons are emitted by metals when these are bombarded by positively charged particles. According to Baerwald, how-

ever, positively charged hydrogen atoms must have an amount of energy greater than that due to a fall through 900 volts before the emission of electrons becomes appreciable.¹ The quantity of electrons emitted is much the same whatever the metal may be against which the positive particles strike. The energy possessed by the electrons when they are ejected from the metal does not exceed that which would be acquired through a fall of potential of about 20 volts. As the energy possessed by the positively electrified particles in tubes of the kind used to study positive rays is far greater than the minimum of 900 volts required to develop electrons, part at least of the cathode stream from the electrode must be due to the impact of positively charged particles against the cathode. As, however, we can get cathode rays with a potential difference of less than 900 volts there must be other agencies also at work: such, for example, as the ionization of the molecules of the gas by the positive particles and the incidence of radiation produced by the discharge, and having the character of soft Röntgen radiation with a wave length small compared with that of the type of ultra-violet light which can get through quartz or even through fluorite. We know that radiation of this type exists in the tube; we know, too, that radiation of this kind when it falls upon metals causes them to emit a stream of electrons, so that part of the cathode stream must be due to this cause. How much is due to this and how much to the previous one has not yet been determined. Wehnelt (*Ann. der Phys.*, 41, p. 739, 1913) has shown that any ultra-violet light which can pass through fluorite does not produce an appreciable effect on the emission of the cathode stream.

The places from which the positive rays originate can be

¹ Horton and Davis (*Proc. Royal Soc.*, 95, p. 333, have detected the emission of electrons from a metal plate struck by positive helium atoms with energy as low as 20 volts.

traced in a very simple way by means of a screen covered with a layer of fused lithium chloride. This substance when struck by rapidly-moving positively-electrified particles phosphoresces with a deep red light; the red lithium line being very prominent when the light is examined with the spectroscope. When lithium chloride is struck by cathode rays the phosphorescence is steely blue and the spectrum is continuous. To explore the tube for positive rays a thin rectangular strip of mica or metal covered with the fused chloride is attached to a closed glass tube which contains a piece of iron and can slide along the bottom of the discharge tube. The strip can be moved to or from the cathode by moving the piece of iron along the tube by a magnet. If we start with the mica strip near to the cathode we find that the anode side of the screen is a brilliant red, proving that in this region there are plenty of positive rays moving up to the cathode. When the strip is pulled further away from the cathode the red light on the anode light persists and is quite bright until the screen almost reaches the limit of the dark space close to the negative glow, when it gets into the negative glow the phosphorescence on the anode side disappears. This shows that many of the positive rays start from close to the junction of the dark space and the negative glow. It is surprising to find how short is the distance which the screen has to travel from the boundary of the negative glow for the red phosphorescence to be quite marked. As at this end of the dark space the electric force is very feeble, the charged particles cannot have fallen through more than a small fraction of the potential difference between the anode and the cathode.

The negative glow is thus a most important place for the manufacture of the positively charged particles which form the positive rays; the study of the positive rays enables us, as we shall see, to determine the character of these particles.

ON THE NATURE OF THE POSITIVE RAYS, THEIR DEFLECTION BY ELECTRIC AND MAGNETIC FORCES

As cathode rays were proved to be negatively electrified particles by the study of the deflections they experience when acted on by magnetic and electric forces, and as these deflections gave the means of finding the mass and velocity of the cathode particles, it was natural to attempt to apply the same methods to the positive rays. It was not, however, until twelve years had elapsed since the discovery of the rays that any effect of a magnetic field on them was detected. A small permanent magnet held near a bundle of cathode rays produces a very appreciable effect; it has, however, no apparent action on the positive rays: as a matter of fact the deflection of the positive rays due to a magnetic field is at most about 2 per cent of the deflection of cathode rays in the same tube. In 1898, however, Wien, by the use of very powerful magnetic fields, proved that the positive rays were deflected by magnetic forces.¹

Before discussing Wien's experiments it will be convenient to consider the theory of the deflection of a moving electrified particle by a magnetic field. The force acting on the moving particle is at right angles to the magnetic force, at right angles also to the direction of motion of the particle, and is equal to $eHv\sin\phi$, where H is the magnetic force at the particle, v the velocity of the particle, ϕ the angle between H and v , and e the charge on the particle. Since this force is always at right angles to the direction of motion of the particle it will not alter the speed of the particle but only the direction in which it is moving. Suppose that the particle is originally projected with a velocity v parallel to the axis of x , and that it is moving in a magnetic field arranged so as to be

¹ W. Wien, "Verh. d. phys. Gesell.," 17, 1898.

very approximately in the direction of the axis of x , the direction of the force along the particle will be parallel to the axis of y , and this will be the direction in which it will be deflected. If y is the deflection in this direction at the time t , m the mass of the particle, H the magnetic force parallel to the axis of Z , and e the charge carried by the particle, the equation of motion of the particle is

$$m \frac{d^2y}{dt^2} = eH \frac{dx}{dt}$$

Integrating this equation we get

$$m \frac{dy}{dt} = \int_0^t eH \frac{dx}{dt} dt = \int_0^x eH dx \quad \dots \quad (1)$$

if the origin of co-ordinates is taken at the point of projection ; for since the particle was projected parallel to the axis of x , $\frac{dy}{dt} = 0$ when $x=0$. Now if the deflection of the particle is small $\frac{dx}{dt}$ will, neglecting the squares of small quantities, be equal to v , and $\frac{dy}{dt}$ to $v \frac{dy}{dx}$. On this assumption equation (1) may be written

$$mv \frac{dy}{dx} = \int_0^x eH \cdot dx;$$

hence if y is the deflection when $x = l$

$$mvy = \int_0^l \left\{ \int_0^x eH dx \right\} dx.$$

Integrating by parts we have

$$\begin{aligned} mvy &= l \int_0^l eH dx - \int_0^l xeH dx \\ &= e \int_0^l (l-x) H dx \end{aligned}$$

or writing A for

$$\begin{aligned} &\int_0^l (l-x) H dx \\ y &= \frac{e}{mv} A. \end{aligned}$$

A depends merely upon the strength of the magnetic field and the distance from the point of projection at which the deflection is measured ; it is quite independent of the charge, mass, or velocity of the particle.

If the magnetic field is that between two poles of an electromagnet placed close together and reaching up to the point of projection of the particle, then if a is the breadth of the pole pieces, H is approximately constant from $x=0$ to $x=a$ and vanishes from $x=a$ to $x=l$. Substituting this value for H in the expression for A we find

$$A = a \left(l - \frac{a}{2} \right) H$$

when H is the magnetic force between the poles. When this approximation is not sufficiently accurate and we have to take into account the stray magnetic field beyond the poles as well as the variation of the magnetic force between the poles, A may be conveniently determined by the following method.¹ Wind a coil of triangular section DEF , the base DF being equal to l , the angle EDF a right angle, and DE

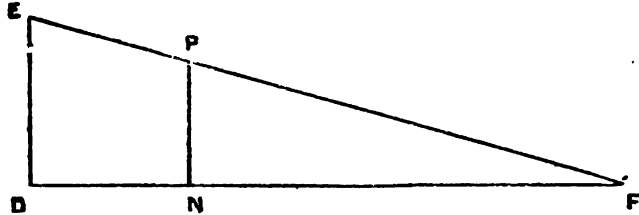


FIG. 8.

small compared with the depth of the pole pieces of the electromagnet. Place the coil so that DF is along the direction in which the particle is projected, D being at the point of projection and F at the distance at which the deflection is measured, connect up the coil with a ballistic

¹ J. J. Thomson, "Phil. Mag.," VI, xviii, p. 844.

galvanometer, or, what is more convenient, with a Grassot flux meter, and determine the number of lines of magnetic force which pass through this coil when the electromagnet is made or broken ; from this number we can easily determine the value of A. For if N is this number, then we see from Fig. 8 that

$$N = \int_0^l H \times PN \cdot dx$$

and from the figure

$$\frac{PN}{DE} = \frac{FN}{FD} = \frac{l-x}{l}$$

$$\begin{aligned} \text{hence } N &= \int_0^l H \cdot \frac{DE}{l} (l-x) dx \\ &= \frac{DE}{l} \int_0^l H(l-x) dx \\ &= \frac{DE}{l} \cdot A. \end{aligned}$$

Thus when N is known A can be determined at once.

ELECTROSTATIC DEFLECTION OF THE PARTICLE

Let us suppose as before that the particle is projected with a velocity v parallel to the axis of x : let the electric force acting on the particle be parallel to the axis of z and equal to Z , then the equation of motion of the particle under the electric force is

$$m \frac{d^2 z}{dt^2} = eZ.$$

When the deflection is small, $\frac{d^2 z}{dt^2} = v^2 \frac{d^2 z}{dx^2}$ approximately, and hence

$$mv^2 \frac{d^2 z}{dx^2} = eZ$$

$$\text{or } z = \frac{e}{mv^2} \int_0^l \left(\int_0^x Z dx \right) dx$$

$$= \frac{e}{mv^2} B$$

where $B = \int_0^l \left(\int_0^x Z dx \right) dx.$

Thus B is quite independent of the charge, mass, or velocity of the particle, and depends merely on the distribution of the electric field and the distance from the point of projection at which the deflection is measured.

A very convenient method of producing the electric field is to have two parallel plates perpendicular to the axis of z ; in this case the electric field is approximately constant between the plates and vanishes outside them. If b is the length of the plates measured parallel to the axis of x , and if one end of the plates just comes up to the point from which the particle is projected, putting $Z=Z$ from $x=0$ to $x=b$, and $Z=0$ from $x=b$ to $x=l$, we find that $B=Zb \left(l - \frac{b}{2} \right)$

so that if s is the deflection when $x=l$

$$s = \frac{e}{mv^2} Zb \left(l - \frac{b}{2} \right).$$

The electric field is not absolutely constant between the plates, it is greater close to the edges than in other parts of the field, nor does it absolutely vanish at all places outside the plates; when great accuracy is required these points have to be taken into account in the calculation of B . A method by which this may be done was given by the author in the "Phil. Mag.," VI, vol. xx, p. 752.

If the particle is acted on simultaneously by magnetic and electric forces parallel to the axis of z , we may, if the deflections are small, superpose the effects due to the magnetic and electric forces, so that the y , z deflections of the particle parallel to the axis of y and z respectively are given by the equations

$$y = \frac{e}{mv} A (1)$$

$$z = \frac{e}{mv^2} B (2)$$

Thus if a stream of charged particles of different kinds (i. e. with different values of e/m) were projected from the origin with different velocities parallel to the axis of x , in the absence of electric and magnetic forces they would all strike a screen at $x=l$ at the same point. When, however, they are submitted to the action of electric and magnetic forces they get sorted out, and no two particles strike the same point on the screen unless they are moving at the same speed and also have the same value of e/m . If we know the deflected position of the particle we can by equations (1) and (2) calculate both the values of v and also the value of e/m ; we have from these equations

$$v = \frac{y}{z} \frac{B}{A} (3)$$

$$\frac{e}{m} = \frac{y^2}{z} \frac{B}{A^2} (4)$$

Thus y/z will be constant for all particles moving with a given speed whatever may be their charge or mass, hence all such particles will strike the screen in a straight line passing through the undeflected position of the particles.

Again, for the same kind of particle y^2/z is constant whatever may be the velocity of the particles, hence particles of the same kind will all strike the screen in a parabola with its vertex at the undeflected position of the particles, and there will be as many of these parabolas as there are different kinds of particles.

In the preceding investigation we have assumed that the pressure of the gas was so low that we could neglect the resistance the gas offered to the motion of the positive

particles through it. If this resistance is represented by a retarding force equal to R times the velocity we can show, if we neglect terms involving squares and higher powers of R , that the term in A^2/B , which is proportional to l , and which in most cases is by far the most important, is not affected by the resistance.

WIEN'S PROOF OF THE MAGNETIC AND ELECTRIC DEFLECTION OF THE RAYS

W. Wien¹ applied this method to demonstrate the magnetic and electric deflections of the positive rays; he proved in this way that the positive rays contained electrified particles, and the direction of the deflections showed that they were positively charged. He calculated by the formulae we have just given the values of e/m and v for these particles.

The method used by Wien is illustrated in Fig. 9.

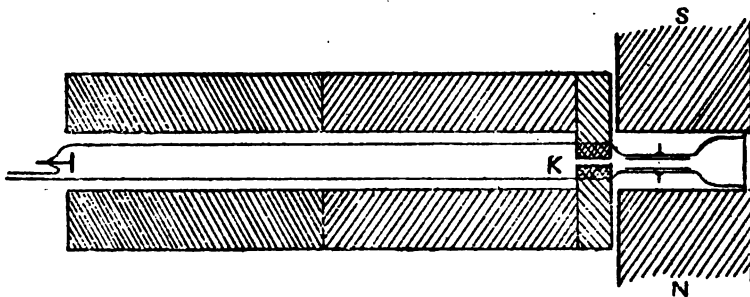


FIG. 9.

The cathode K was an iron cylinder 3 cm. long with a hole 2 mm. in diameter bored through it, the anode was at the top of the tube. The lower end of the tube was made as flat as possible so as to facilitate the observation of the spot of luminosity produced by the impact of the positive rays on

¹ W. Wien, "Wied. Ann.," 65, p. 440, 1898; "Ann. der Phys.," 8, p. 224, 1902.

the glass. The magnetic field was produced by an electromagnet whose poles were at N and S : it is necessary to shield the part of the tube through which the discharge is passing from the magnetic field ; if this were not done the discharge would be so much affected by the magnet that trustworthy observations would be impossible ; the tube was shielded by surrounding it with thick sheets of soft iron. The electrostatic field was produced between two parallel metal plates which were connected with the terminals of a voltaic battery. When the magnetic and electric fields were acting, the round spot of phosphorescence due to the positive rays coming through the hole in the cathode was drawn out into a straight band. Since the band was straight the velocities of the different particles producing it would all be the same ; the values of e/m for these particles would, however, all be different. When the tube was filled with hydrogen, Wien found that the value of e/m for the most deflected portion was 7545 ; the value of e/m for a charged atom of hydrogen in the electrolysis of water is 10,000. In his first set of experiments Wien found that on filling the tube with oxygen the value of e/m for the most deflectible rays was 9800 in one experiment ; in later experiments, after very pure oxygen had flowed through the tube for a long time, he found on first passing the discharge through the tube very much smaller values of e/m than for hydrogen, but the higher values reappeared after the discharge had passed for a short time.

The deflections of these rays by the electric and magnetic fields show that they are positively charged particles, the values of e/m obtained for these particles show also that they are very much more massive than the particles in the cathode rays for which $e/m = 1.7 \times 10^7$. The displaced particles in this experiment were spread out into a continuous straight band, indicating, according to the theory of the effect of

electric and magnetic fields on charged particles, that in the positive rays there are particles giving all values of e/m from zero up to about 10,000. This would imply, assuming that the charge on each particle is the same, that the masses of the particles vary *continuously* from a certain value comparable with the mass of an atom of hydrogen up to a value which is very large in comparison with this mass. This *continuous* variation in the value of e/m is contrary to what might be expected, for, from the molecular theory of gases, the masses available in the gas would not vary continuously but would increase by finite steps, the smallest step being the mass of the atom of hydrogen: again the results of many different lines of investigation lead to the conclusion that e like m does not vary continuously, but that all electrical charges are multiples of a unit charge whose value in electrostatic measure is 4.8×10^{-10} . Again it would appear from the uniformity of the luminosity produced by the displaced positive rays that there is no special kind of atom which is predominant among these rays. For if there had been a great excess of particles of one kind, these would have produced a very bright spot on the glass if they had all been moving with the same velocity, or a bright arc of a parabola if they had been moving with varying velocities. The experiments now to be described, which I made in 1906, show that the discrepancies between the theory and the experiments are due to the pressure of the gas in the discharge tube in Wien's experiments having been so high that the particles forming the positive rays collided with the molecules of the gas whilst they were passing through the electric and magnetic fields. The effect of these collisions is to ionize the gas so that the gas through which the positive rays have to pass is full of charged particles, some charged with positive, others with negative electricity. The result of the presence of this electrification is that some of the positive

ray particles which were charged before they entered the electric and magnetic fields have their charges neutralized before they pass through them, and thus do not experience the full deflection. On the other hand others which had got neutralized before they entered the field strike against an electron or atom and, losing an electron, get ionized by the collision. In this way they acquire a positive charge in the field and are deflected by an amount which depends upon the stage in their journey at which they picked up the charge. Thus the quantities we denoted by A and B (see p. 21) vary from particle to particle, and the values of e/m cannot be obtained from equation of the type (3) and (4) where A and B are calculated on the supposition that the particles are charged for the whole of the time they are between the poles of the magnet and the plates of the condenser.

In my first experiments¹ on this subject the arrangement was as follows: The cathode K (Fig. 10) had a hole bored

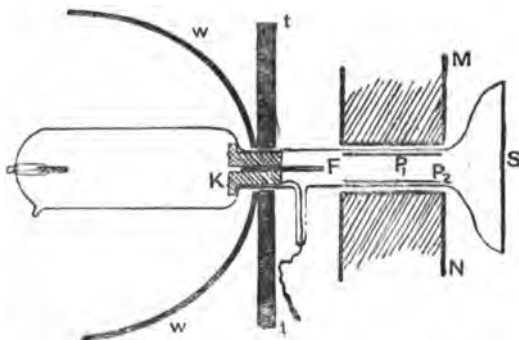


FIG. 10.

through it and in this hole a tube F with a very fine bore was firmly fixed; it is essential to the success of the experiment that the bore of the tube should be exceedingly fine so as to

¹ J. J. Thomson, "Phil. Mag.," VI, xiii, p. 561.

get a small, well-defined patch when the positive rays strike the screen, S. This was a flat glass plate uniformly covered with powdered willemite which phosphoresces much more brightly than glass when struck by the rays. M and N are the poles of the electromagnet, and $P_1 P_2$ the parallel metal plates used to produce the magnetic and electric fields respectively; t, t , W, W are sheets of soft iron to screen the discharge in the tube from the magnetic field due to the electromagnet.

The effect observed on the screen depended to a very great extent upon the pressure of the gas in the tube; when this was not exceedingly low, the phosphorescence under the action of the magnetic and electric fields was drawn out into two continuous straight bands as in Fig. 11. The value of e/m



FIG. 11.



FIG. 12.

for the most deflected portion of the band a was 10^4 , for that of band b , 5×10^8 . These correspond to the values of e/m for the atom and molecule of hydrogen respectively, suggesting that the one band is due to hydrogen atoms, the other to hydrogen molecules. When the tube contains helium

there are three bands to be seen as in Fig. 12. The values of e/m at the tips of these bands are respectively 10^4 , 5×10^3 , 2.5×10^3 , indicating that we have here again bands due to the atom and molecule of hydrogen, and in addition a new one due to atoms of helium, for (as the atomic weight of helium is 4) e/m for the helium atom is one quarter of that for the hydrogen atom. It is remarkable that the slope of these bands, and therefore, by page 21, the velocity of the particles varies little if at all with the potential difference between the anode and cathode of the discharge tube. This potential difference may be increased three or four times without producing any appreciable effect upon the slope of the bands of phosphorescence. When air is in the tube, the appearances of the bands is much the same as when the tube contains hydrogen, though the phosphorescence is not so bright. The most conspicuous things on the screen in this case are the two bands corresponding to the atom and molecule of hydrogen respectively.

In addition to the two bands deflected in the direction indicating a positive charge on the particles, there is another fainter band deflected in the opposite direction which must therefore be due to particles with a negative charge. The value of e/m for the tip of this band is 10^4 , thus these negative particles are not cathode rays for which e/m is 1.7×10^7 , but have a mass equal to that of an atom of hydrogen. The existence of particles deflected in the opposite direction to that of the majority of the particles had also been observed by Wien.

EFFECT AT VERY LOW PRESSURES

When the pressure is reduced to as low a value as is possible the appearance of the luminosity on the screen entirely changes. At these low pressures it is exceedingly

difficult to get the discharge to pass through tubes of moderate size when the cathodes are made of aluminium or any of the metals ordinarily used for this purpose, and there is great danger of sparks passing through the glass and breaking the tube. This can be avoided to a great extent by facing the cathode with a thin layer of calcium, or smearing the face of the cathode with the liquid alloy of sodium and potassium. This reduces considerably the difficulty of getting the discharge to pass and diminishes the risk of perforating the tube. The appearance at these low pressures when hydrogen or air is in the tube is shown in Fig. 13. It



will be noticed that the straight bands of phosphorescence have almost disappeared and that most of the phosphorescent light is concentrated into two parabolic curves which are connected with the undeflected spot by straight faintly luminous lines. The value of e/m for one parabola is 10^4 , that for the other 5×10^8 so that they are due to the atom and molecule of hydrogen respectively. At these low pressures the luminosity in the negative direction disappears. But both at the low and higher pressure there is, even when the magnetic and electric fields are in action, an appreciable amount of luminosity at the position occupied by the undeflected spot.

FIG. 13.

When, as in these early experiments, the pressure is the same in all parts of the tube, there is considerable advantage in using very large glass vessels for the discharge tubes when studying positive rays; with large vessels the pressure can be made very small before the tube offers great resistance to the passage of the discharge through it. The increase in the difficulty of getting the discharge to pass comes in at the pressure when the dark space round the cathode reaches the walls of the tube. When the tube is big the walls are far

When, as in these early experiments, the pressure is the same in all parts of the tube, there is considerable advantage in using very large glass vessels for the discharge tubes when studying positive rays; with large vessels the pressure can be made very small before the tube offers great resistance to the passage of the discharge through it. The increase in the difficulty of getting the discharge to pass comes in at the pressure when the dark space round the cathode reaches the walls of the tube. When the tube is big the walls are far

away from the cathode and the pressure has to be exceedingly low before the dark space reaches the sides of the tube. We can work with much lower pressures with these large tubes and therefore reduce the obstruction which the positive rays meet with in their passage from the cathode to the screen. Using vessels of about 2 litres capacity I have observed¹ on a willemite screen the parabolas corresponding to carbon, oxygen, neon, and mercury vapour as well as those corresponding to the atom and molecule of hydrogen and the atom of helium. The photographic plate is, however, for most purposes a much more convenient detector than a willemite screen. It is more sensitive, it gives a permanent record, and measurements can be made with much greater accuracy on the plate than they can on the screen. Before entering into the discussion of the theory of the positive rays it is desirable to describe the results obtained with the photographic method, as well as the experimental details by which these results have been procured.

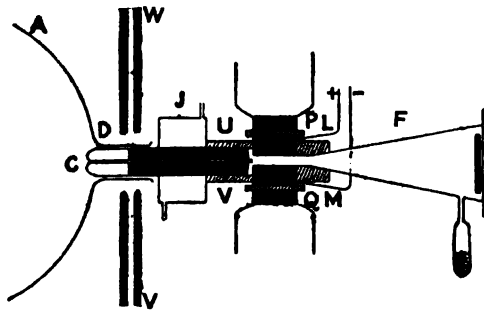


FIG. 14.

The apparatus now in use at the Cavendish Laboratory is represented in Fig. 14. The discharge takes place in a large glass flask A: a volume of from one to two litres is a

¹ J. J. Thomson, "Phil. Mag.," VI, xx, p. 752, 1910.

convenient size for this purpose. The cathode C is placed in the neck of the flask. The position of the front of the cathode has a very considerable influence on the brightness of the positive rays and ought to be carefully attended to. The best position seems to be when the front of the cathode is flush with the prolongation of the wider portion of the flask. The shape of the cathode is represented in section in Fig. 15: the face of the cathode is made of aluminium, the other portion is soft iron. A hole is bored right through the cathode to admit the fine tube through which the positive rays are to pass. Care should be taken to bore this hole so that its axis is the axis of symmetry of the cathode. The tube through which the positive rays pass is fastened into the cathode in the way shown in Fig. 15.



FIG. 15.

The bore of this tube will vary with the object of the experiment. If very accurate measurements are required, the diameter of the tube must be reduced to $\cdot 1$ mm. or less. With these very fine tubes, however, very long exposures ($1\frac{1}{2}$ to 2 hours) are necessary. The length of the tube is about 7 cm. The tubes are prepared by drawing out very fine bore copper tubing until the bore is reduced to the desired size. The tube is straightened by rolling it between two plane surfaces, and great care must be taken to get the tube accurately straight, as the most frequent cause of dimness in the positive rays is the crookedness of the tube. After long use the end of the tube nearest the discharge tube gets pulverized by the impact of the positive rays, and the

metallic dust sometimes silts up the tube and prevents the rays getting through. The cathode is fastened in the glass vessel by a little sealing-wax, and a similar joint unites it to the ebonite box, UV. To keep the joints cool and prevent any vapour coming from the wax, the joints are surrounded by a water jacket J through which a stream of cold water circulates.

The electric field is produced between the faces of L and M which are pieces of soft iron with plane faces. These are fitted into the ebonite box UV so that their faces are parallel: the distance between the faces should be small compared with their lengths. In many of the experiments described subsequently the length of the faces was 3 cm. and their distance apart 1.5 mm. Their faces are connected with the terminals of a battery of small storage cells: in this way any required difference of potential can be maintained between them.

These pieces of soft iron practically form the poles of an electromagnet, for the poles of the electromagnet P and Q are made of soft iron of the same cross section as L, M; they fit into indentations in the outside of the ebonite box and are only separated from the pieces L, M, by the thin flat pieces of ebonite which form the walls of the box. This arrangement makes the magnetic field as nearly coterminous as possible with the electric, which is desirable in several of the experiments. To screen off the magnetic field due to the electromagnet, thick iron plates V, W, Fig. 14, are placed round the neck of the tube.¹

A conical glass vessel F 40 cm. long is fastened by wax

¹ Though an increase in the distance of the photographic plate from the cathode increases the deflection of the parabolas for the same electric and magnetic fields, the definition is not so good. It is advisable when sharp definition is very important to use strong fields and place the photographic plate as near the cathode as is convenient.

to the ebonite box while the other end is fixed to the

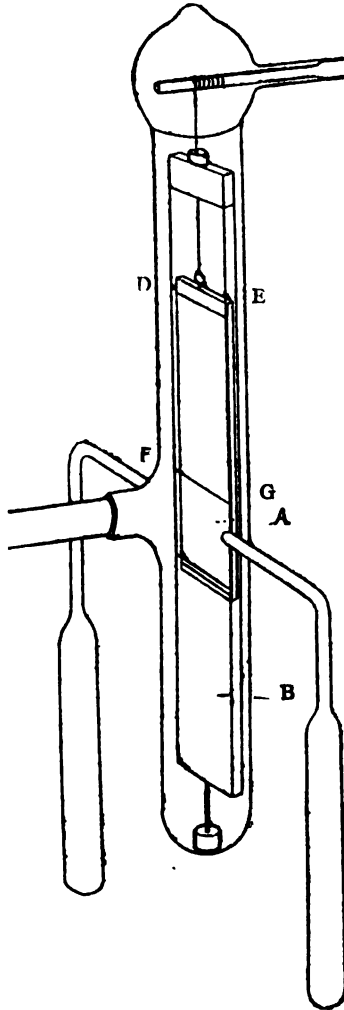


FIG. 16.

apparatus which contains the photographic plate. One form of this, designed by Mr. Aston, is represented in Fig. 16. The photographic plate is suspended by a silk thread wound round a tap T which fits into a ground glass joint; by turning the tap the thread can be rolled or unrolled and the plate lifted up or let down. The plate slides in a vertical box B made of thin metal; this is light tight except at the openings A which are placed so that the positive rays can pass through them. The openings are on both sides of the box and about 5 cm. in diameter. When the silk thread is wound up the strip DEFG of photographic plate in the box is above the opening A, so that

there is a free way for the rays to pass through A and fall on a willemite screen behind it. This screen is not used for purposes of

measurement, but only to see before taking the photograph that the tube is giving an adequate supply of positive rays. The box is sufficiently large to hold a film long enough for two or more photographs ; if it is wished to take two photographs, the plate is lowered until the bottom half comes opposite to the opening A, a photograph is taken in this position, the plate is then let down still further until the top half of the plate comes opposite to the opening, then a second photograph is taken. This plan is convenient because the deflections of the different kinds of positive rays differ so much that it is difficult to measure them accurately when they are all on one plate. For example, the magnetic deflection of the hydrogen atoms is about fourteen times that of the mercury one, thus if the deflection of the hydrogen atom is within the limits of the plate, that of the mercury atom would be too small to measure accurately. When we can take two photographs, however, without opening the tube, we may take one with a small magnetic field to get the deflection of the hydrogen atom, and the second with a much larger one to get the deflection of the mercury one.

Two tubes containing coco-nut charcoal are fused to this part of the apparatus ; by immersing these in liquid air the pressure can be made exceedingly small. As the only communication between this part of the apparatus and that through which the discharge passes is through the long and very narrow tube in the cathode, it is possible to have the pressure on the camera side of the apparatus very much less than the pressure on the side through which the discharge is passing.

A Gaede pump worked by a motor is connected with the discharge tube, and keeps the pressure in this part of the apparatus at a suitable value.

When the rays in some particular gas are under examination

a constant stream of this gas is kept flowing through the discharge tube. The gas is stored in the vessel A, Fig. 17,

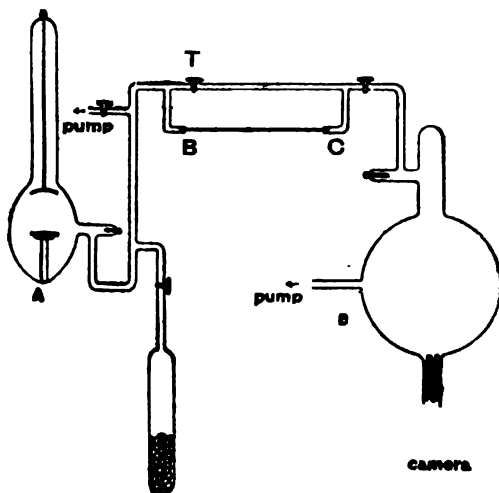


FIG. 17.

over a column of mercury: this vessel is connected with the discharge tube by the system shown in Fig. 17, where BC is a long and fine capillary tube. When the tap T is turned the gas has to pass through this capillary: it does so exceedingly slowly. The rate can be adjusted by raising or lowering a mercury reservoir connected with A; this is held in such a position that when the Gaede pump is in action the pressure in the discharge tube is such as to give well-developed positive rays.

The curves on the photographic plates made by the positive particles are measured by the apparatus represented in Fig. 18. The photographic plate is clamped in a holder A, and the position of any point on it is determined by moving the carrier C until the tip of the needle NN comes just over the point in question. The carrier C has two

movements, one parallel to the base BB, and the other, by means of the screw S, at right angles to this direction ; the

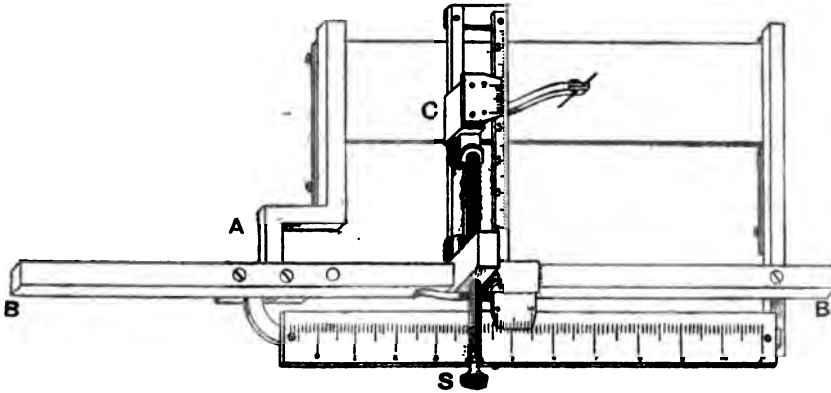


FIG. 18.

position of the point is read off on the two verniers. The plate is placed in the holder so that the direction of the magnetic deflection is parallel, and that of the electrostatic deflection at right angles, to BB.

THE METHOD OF HOT CATHODES

Another method by which positive rays with a great range of velocities may be produced is to use for the cathode a Wehnelt cathode—i. e. a spot of lime round a hole in a strip of platinum, or a spiral of tungsten wire raised to incandescence by an electric current. The hot cathode emits electrons, and these, when there is an adequate potential difference between the anode and cathode, ionize the gas in the discharge tube; the positive ions produced by this ionization move up to the cathode and pass through the hole in the strip or the spaces between the wires. A fine tube placed just behind the cathode isolates a thin pencil of rays which pass through electric and magnetic fields as in

the previous method. When the voltage between the cathode and anode is less than a few hundred volts the positive ions have not sufficient energy to affect the photographic plate; they may, however, after passing through the fine tube be accelerated by inserting two parallel plates of fine wire gauze between the end of this tube and the beginning of the electric field. These plates are connected with some source of constant difference of potential. In this way positive ions produced with small difference of potential in the discharge tube can be studied conveniently. The accelerating field can be dispensed with if, instead of registering the rays by their photographic action, we use the electrical method described on page 124. The method of the hot cathode was first employed in the Cavendish Laboratory by Professor Knipp¹ who accelerated the rays and detected them photographically. It has also been employed by Dempster who used the electrical method of detection. The hot cathode method has the merit of permitting the use of a much wider range of pressures and voltages without changing the discharge tube than the other method, and thus can be employed for special investigations beyond the power of the first method. The discharge tube, too, may be of much smaller dimensions, a matter of importance in experiments when it is necessary to keep it at a high temperature. The photographs which have hitherto been obtained by this method are not, however, comparable in clearness with those taken by the first method.

A method has been devised lately by Mr. Aston ("Phil. Mag.," Dec. 1919) which has the advantage of bringing particles with the same value for e/m but with different velocities together on the photographic plate and so avoid-

¹ Knipp, "Phil. Mag.," VI, xxii, p. 926, 1911. Dempster, "Phil. Mag.," VI, xxxi, p. 438, 1916.

ing the weakening in intensity due to the spreading of these particles over a considerable length of arc.

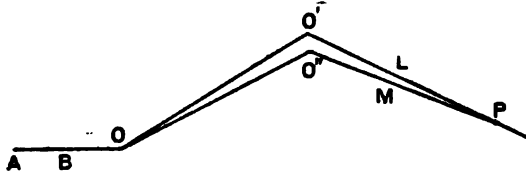


FIG. 19.

The elementary theory of the method is as follows: Suppose that AB is a stream of positive particles, let one of these particles be deflected through an angle θ by an electric field at O, when it gets to O' let it be deflected in the opposite direction through an angle φ by a magnetic field, its path after leaving this field being along O'L. Let a particle with a slightly different velocity be deflected by the electric field along OO'' and by the magnetic field along O''M, then if O'L and O''M intersect at P, P will be a focus at which the rays with different velocities will overlap.

To calculate the position of this point we notice that by equations (1) and (2) on page 21 if v is the velocity of the particles

$$\theta = \frac{C}{v^2}, \quad \varphi = \frac{C'}{v}$$

and therefore

$$\varphi^2 = C''\theta$$

where C, C', C'' are independent of v , hence

$$\frac{2\delta\varphi}{\varphi} = \frac{\delta\theta}{\theta} \dots \dots \dots (1)$$

But remembering that φ and θ are small angles we see from the figure that

$$OO' \times \delta\theta = O'P\delta(\varphi - \theta)$$

or from (1)

$$\frac{O'P}{OO'} = \frac{2\theta}{\varphi - 2\theta} \dots \dots \dots (2)$$

When $\varphi = 2\theta$, $O'P$ is infinite, i. e. the rays with different velocities come out parallel, when $\varphi = 4\theta$ $O'P = OO'$.

When the particles are chiefly those which form the heads of the parabolas, the particles with different values of e/m will have approximately the same kinetic energy, and so will be equally deflected by the electrostatic field, hence θ will be much the same for all these particles, so that by equation (2) the foci will all be on the curve whose equation is

$$O'P(2\theta - \varphi) = \text{constant.}$$

As θ and φ are small this will be approximately a straight line in the direction given by $\varphi = 2\theta$, and passing through the point given by $\varphi = 4\theta$; $O'P = OO'$.

The apparatus by which this method is carried out is represented in Fig. 20, taken from a paper by Mr. Aston, "Phil. Mag.," May 1920.

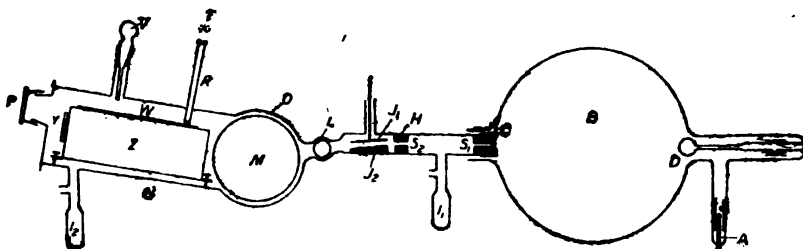


FIG. 20.

The discharge tube B is an ordinary X-ray bulb about 20 cm. in diameter. The anode A is an aluminium wire surrounded by an insulated aluminium tube to protect the glass walls. The aluminium cathode C, about 2.5 cm. wide, is concave and placed just at the neck of the bulb. To protect the opposite end of the bulb from being melted by the concentrated beams of cathode rays, a silica bulb D about 1.2 cm. in diameter is mounted as shown in the figure.

The arrangement of slits S_1 , S_2 , to produce the fine pencil

of positive rays is shown in Fig. 21. The slits, which are 0.5 cm. wide and 2 mm. long, are about 10 cm. apart and can be adjusted to be accurately parallel by means of their

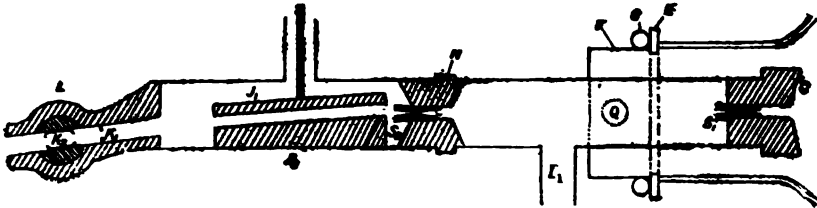


FIG. 21.

diffraction patterns. The pencil of rays is split up into an electric spectrum by passing between the plates J_1 and J_2 , 5 cm. long and 2.8 mm. apart, which can be maintained at any required difference of potential. K_1 and K_2 are the diaphragms, K_1 is fixed and K_2 mounted on the bore of a carefully ground stop-cock. After leaving the diaphragm, the rays pass between the pole pieces M of a large Du Bois magnet, these are soldered into a brass tube O which forms part of the

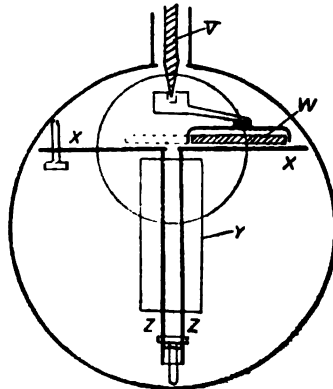


FIG. 22.

camera N , which is made of stout brass tube 6.4 cm. diameter. The arrangement for holding the photographic plate W is shown in Fig. 22.

The rays, after being magnetically deflected, pass between two vertical brass plates about 3 mm. apart and reach the photographic plate through a narrow slot 2 mm. wide and 11.8 cm. long cut in the horizontal metal plate XX. The photographic plate, which is a 2 cm. strip cut lengthwise from a 5×4 plate, is supported at its ends on two narrow transverse rails which raise it just clear of the plate XX. The plate is moved parallel to itself over the slot by mechanism which is set in action by the torque rod V working through a ground-glass joint. Y is a willemite screen, and P a cap with a plate-glass back.

The adjustment of the plate-holder to make the rays come to a focus on the plate was made by taking a series of exposures of the hydrogen lines with different magnetic fields on a large plate placed nearly vertically in the camera. By developing this the actual paths of the rays could be determined and the foci calculated. The final adjustment was made by trial and error, and was exceedingly tedious, as air had to be admitted and a new plate inserted after each tentative small alteration of the levelling screws.

The plates were measured against a standard Zeiss scale by a comparator. To measure faint lines it is necessary that the magnifying power of the eye-piece of this instrument should be very small, otherwise the edges of the lines are too indistinct to be measurable.

Dempster ("Phys. Review," XI. p. 316) has employed a method which had previously been used to determine e/m for cathode rays. It consists in finding the strength of a uniform magnetic field which will bend the rays into a circle of radius a . If H is the strength of the magnetic field, v the velocity of the particle

$$\frac{m}{e} = \frac{Ha}{v}$$

This method is applicable only when all the particles of the same kind are moving with the same velocity; if this velocity is due to a fall through a potential difference V

$$\frac{1}{2} mv^2 = Ve,$$

and the preceding equation becomes

$$\frac{m}{e} = \frac{H^2 a^3}{2V}.$$

DISCUSSION OF THE PHOTOGRAPHS

With the arrangement shown in Fig. 10 the appearance of a typical photograph produced by the impact of the positive rays on the plate when the pressure on the camera side of the apparatus is reduced to about '001 mm. of mercury is shown in Fig. 1, Plate I. In this and the following figures the deflection due to the magnetic field is vertical, while that due to the electrostatic field is horizontal. It will be seen that the curves on the plate are of two different types.

1. A series of separate parabolic arcs, often of considerable length. From the theory given on page 21 it will be seen that each of these parabolas arises from particles having the same value of e/m , and that these particles have retained their charges throughout the whole of the journey through the electric and magnetic fields. As the velocity of a particle is by equation (3), p. 21, proportional to the tangent of the angle which the line joining the origin to the point where the particle hits the screen makes with the horizontal, it follows there is a considerable range of velocities among the particles having the same value of e/m . In many cases we have velocities among the same kind of particles differing so much that the velocity of the slowest ones is less than

one-fifth that of the fastest. In some cases the parabolas are of fairly uniform intensity along the whole of their length. In others, as in that shown in Fig. 2, Plate I., the head of the parabola (the part least deflected) is considerably brighter than the rest of the curve, while sometimes, as in the case represented in Fig. 3, Plate I., there are several spots of maximum luminosity dotted along the parabolic arc.

With some exceptions (to be considered later) the heads of all the parabolas are in the same vertical line, showing that the minimum electrostatic deflection suffered by the particles which produce these curves is the same for all the different kinds of particles. By equation (2) page 21 the electrostatic deflection is proportional to e/mv^2 . If the energy of the particles is due to the fall of the charge through a potential difference V

$$\frac{1}{2}mv^2 = V \cdot e$$

so that $\frac{e}{mv^2} = 1/2V$. Hence as the minimum electrostatic deflection is the same for all the particles, we conclude that the maximum potential through which they have fallen is the same for particles of all kinds. It is natural to conclude that this maximum potential is the difference of potential between the anode and cathode of the discharge tube. It is easy to verify that when the pressure is altered so as to increase this difference of potential the deflection of the heads of the parabolas diminishes.

2. Besides the parabolas there are on the plate a series of straight lines connecting the parabolas with the origin. These are due, I think, to particles which have been charged during a part only of their passage through the electric and magnetic fields. This might happen in two ways. A particle which had got neutralized before reaching these fields might, while passing through them, come into collision with an

electron, get ionized, and acquire a positive charge, and during the rest of its journey be deflected by the electric and magnetic forces. Or again, a particle might be positively charged when it entered the fields, attract an electron whilst in them, get neutralized, and for the rest of its journey be free from electric and magnetic deflections. This view of the origin of these lines seems to me to be proved by the following experiments.

As on this view these lines are due to particles which get charged or discharged in the electric and magnetic fields, their intensity, as compared with that of the parabolas, ought to diminish if the length of these fields is reduced. To test this I took a photograph when the lengths of the electric and magnetic fields were reduced to 1 mm., the intensity of the fields being increased in proportion so as to get deflections comparable with those in the longer fields. With this very short field the straight lines disappeared, and nothing except the parabolas and the undeflected central spot was to be seen on the photographic plate.

Another way of testing this view is to use magnetic and electric fields, which are not coterminous. Let us suppose, for example, that the magnetic field stretches beyond the electric, on the camera side. There will be a part of the field where the particles are exposed to magnetic but not to electric forces. If a neutralized particle gets ionized in this region, it will experience magnetic, i.e. vertical deflection but no electrostatic or horizontal deflection. Thus with a field of this kind we should expect the line due to particles which acquired their charge whilst in the electric field to have the shape shown in Fig. 23. The straight vertical stem near the origin is due to the particles ionized beyond the electric field, the piece running up to join the parabola, to those ionized inside this field, the portion close to the parabola

being due to particles which get ionized almost as soon as they enter the fields. Photographs taken with the magnetic



FIG. 23.



FIG. 24.

field overlapping the electrostatic show this effect very plainly; one of them is reproduced in Fig. 4, Plate I., another in Fig. 1, Plate II.

Let us now consider the case of the charged particles which get neutralized while passing through the field. The part of the line near the origin will be due to particles which get neutralized almost as soon as they enter the field. We have supposed that the magnet was moved towards the camera so that its field overlapped the electric on that side. This will tend to make the electric field overlap the magnetic on the other side, i. e. the side nearest the cathode, so that when a particle first enters the field its deflection is mainly due to the electrostatic force and is therefore horizontal; thus a particle which gets neutralized at the early stages of its journey through the fields will have a horizontal displacement abnormally large compared with the vertical; while those which get neutralized after leaving the electric field will lose vertical but not horizontal deflection. The curves produced on the photographic plate by the particles which get neutralized will thus have a shape something like that shown in Fig. 24. We see that with these overlapping

fields we can distinguish between the lines which are due to particles which have gained a charge in their journey and those which have lost one. The concavities of the two curves are in opposite directions. These two sets of lines are very prominent in photographs taken with apparatus in which care has not been taken to make the fields coterminous ; an example of this is shown in Fig. 4, Plate I. If the fields are coterminous and uniform the two curves coincide and are straight lines passing through the origin.

The rays when they travel through a gas keep passing from a positively charged state into a neutral one and back again to the positive charge. Sometimes instead of becoming positively charged after being neutral they acquire a negative charge, so that as the pencil of positive rays passes through the gas it becomes a mixture of atoms and molecules, some positively charged, others neutral, while some carry a negative charge. This is very clearly shown by the following experiment (J. J. Thomson, "Phil. Mag.," VI, xviii. p. 824, 1910).

The positive rays were produced in a tube made so as to allow room for two electromagnets A and B, Fig. 25, to be

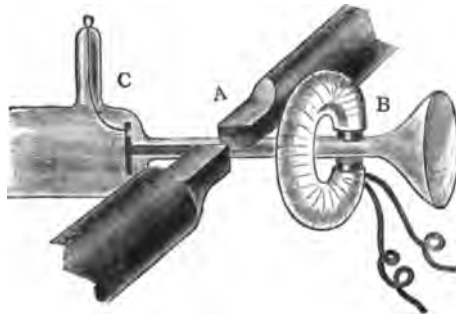


FIG. 25.

inserted between the cathode C and the willemite screen, S. The magnets were placed so that the magnetic force due to

the one nearer the cathode was horizontal and the deflection due to it, therefore, vertical, while the force due to the magnet next the screen was vertical and the deflection due to it horizontal. The deflection due to the two magnets could thus be separated and measured independently. The effects observed when the magnets were applied separately and then in succession are interesting. A typical case when the pressure is such that the only spot visible is that due to the hydrogen atom is represented in Figs. 26 and 27.

Fig. 26 gives the appearance of the screen when the



FIG. 26.

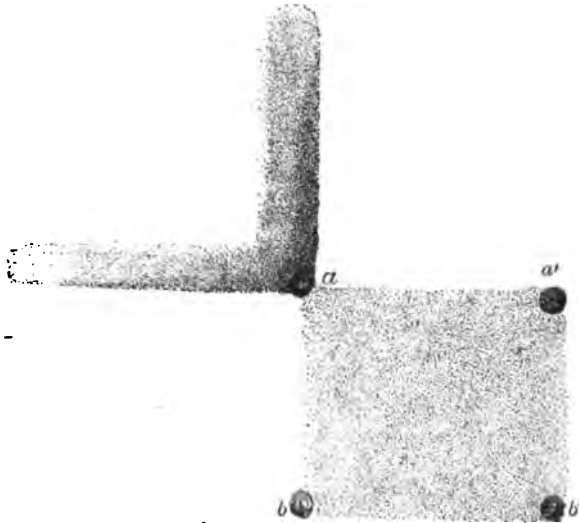


FIG. 27.

magnet next the cathode is the only one in action, *a* is the position of the undeflected spot, *b* that of the deflected, *a* and *b* are connected together by a straight luminous band, the luminous streak above *a* is due to negatively charged particles. Fig. 27 gives the appearance when both magnets are on. If there had been no loss or gain of charge the only effect of the second magnet would have been to remove the spot *b*

horizontally to another place b' , and only two spots, a and b' , would be visible. If, however, the pressure is not very low there are, as a matter of fact, four spots, a, a', b, b' , on the part of the screen corresponding to positive charges as well as considerable luminosity over the rectangle with these points as corners. Let us consider these points in succession; b' has experienced the full horizontal as well as the full vertical deflection, it is therefore produced by particles which have retained their charges while passing through both magnetic fields. Let us now take b ; this spot has the maximum vertical, but no horizontal, deflection. The particles producing this spot must have been charged all the time they were in the field of the magnet A, but have lost their charge before reaching the field of the magnet B. This is an example of a particle losing its charge on its way down the tube. Now consider the spot a' ; this has not been deflected vertically at all, therefore it must be due to particles which were uncharged when they were passing the first magnet A. On the other hand it has experienced the full horizontal deflection, so that the particle must have acquired a charge before reaching the second magnet B: this is an example of a particle acquiring a charge during its path. The appearance of the luminosity due to the negatively charged particles shows that these too gain and lose negative charges in their passage down the tube.

When the pressure was lower than that in the case just considered, though higher than that used in taking most of the photographs reproduced in this book, the spots due to oxygen, the molecule of hydrogen and the atom of hydrogen could be distinguished easily, and it was found that each one has its negative counterpart showing that all these can receive a negative charge. We shall see later on that the hydrogen molecule rarely receives a negative charge at

the pressures at which most of the photographs are taken, though at these pressures the negatively charged hydrogen atom is represented on nearly every photograph. All the spots showed the characteristics exhibited by the one spot, due to the hydrogen atom, in the case previously considered. In this case there are other transformations possible besides the loss or gain of an electric charge. One of the particles might, for example, begin its course as a molecule of hydrogen, and in its path through the gas split up into atoms so that the charged molecule would be represented by a charged atom at the end of its path; there is evidence of this on some of the photographs which will be given later.

The preceding results were obtained when the pressure was considerable; when we reduce the pressure of the gas to the lowest value we can reach by the use of charcoal and liquid air, in the case first considered the luminosity is confined to two spots, one corresponding to the undeflected spot *A* and the other at *b*. All the luminosity inside the rectangle has disappeared along with that arising from particles carrying a negative charge. Investigations on the loss and gain of charge by the positive rays have been made by W. Wien ("Ann. der. Phys.," 39, p. 519, 1912) and by Königsberger and Kutschewski ("Ann. der. Phys.," 37, p. 161, 1912; Sitz. Heidelberg Akad. abh., 1, 1912; Glimme and Königsberger; Sitz. Heidelberg Akad. abh., 3, 1913).

It is natural to connect the loss of charge by the electrified particles and the recharging of the neutral particles with collisions between the particles and the molecules of the gas through which they are moving, and to introduce quantities analogous to the mean free path of a molecule of a gas to fix the rate at which the particles pass from charged to the uncharged state or vice versa. Thus we may introduce the quantities λ_1 , λ_2 , such that e^{-x/λ_1} is the probability

that a charged particle will have retained its charge after passing through a distance x , and that e^{-x/λ_2} is the probability that an uncharged particle will not have regained its charge in the same distance. It is found too that the number of particles, charged and uncharged, diminishes as the pencil of positive rays passes through the gas; we may, therefore, introduce a quantity l such that if N_0 is the number of particles in the beams of positive rays when $x = 0$, then $N_0 e^{-x/l}$ is the number when the beam has passed through a distance x . If every collision between a particle and a molecule of the gas deprived the particle of its charge, if it were charged before the collision, and charged it up if it were uncharged to begin with, then if the collisions were analogous to those between uncharged elastic spheres we should have $\lambda_1 = \lambda_2 = \frac{l}{N\pi S^2}$ where N is the number of molecules per unit volume and S the sum of the radii of the particle and a molecule of the gas through which the particles are passing. It must be remembered, however, that the particles in a pencil of positive rays are by no means homogeneous; some of them are atoms, others are molecules, and in general the atoms and molecules of a considerable number of different gases are present.

A pencil of positive rays becomes diffuse while passing through a gas, showing that the direction of motion of the particles is gradually altered by the collision; the alteration is, however, slight, even when the distance travelled is a considerable multiple of λ_1 and λ_2 . The methods generally used to detect positive rays only take into account the particles which are moving in directions which make small angles with the initial direction of the particles, so that if a particle were deflected through a large angle by a collision it would escape detection and would be counted as one of those absorbed by the gas.

An interesting feature of the transformations which the particles undergo is that they are not accompanied by any change in the velocity large enough to be detected by the methods hitherto employed; right up to the place at which they are absorbed the particles are moving with approximately their original velocity. This has been shown very simply by Königsberger and Kutschewski ("Ann. der Phys.," 37, p. 161) by the following method: At two places, A and B, in the path of a pencil of positive rays they deflected the particles by magnetic forces and adjusted these forces so that at a particular pressure the deflection at B just counterbalanced that at A, thus the particles were not deflected after passing through both the magnetic fields. They found that if this adjustment were made for any particular pressure of the gas through which the particles were passing it held for all pressures at which the positive rays could be observed. If the velocity of the particles were appreciably diminished by a collision, then, since at the higher pressures the particles would make more collisions in traversing the path from A to B, the velocity at B would fall below that at A more at high pressures than at low ones. But the deflections produced by the magnetic fields both at A and B depend on the velocity of the particles, and if a balance is obtained when there is one proportion between the velocities it will be disturbed when that proportion is altered. When we increase the number of collisions the proportion must be altered if there is any appreciable loss of velocity at a collision. The fact that the balance is independent of the number of collisions shows that the collisions are not accompanied by any appreciable loss of velocity.

In the case of the α particles given out by radioactive substances, which are also positively electrified particles though their speed is much higher than that of positive

rays produced by electric discharges, there is a considerable diminution in velocity before they cease to produce appreciable effects. The difference can, I think, be explained by taking into consideration the difference in the velocity of the particles in the two cases. The absorption of an α particle or a positive ray may be regarded either as the result of an impact with a molecule, of such intensity that the particle is deflected through a considerable angle, or as a capture of the particle by a molecule; in either case the probability will diminish rapidly as the energy of the particle increases. The charging and recharging of the positive rays are the results of collisions of a much milder type, and it is probable that the chance of such collisions is not diminished by an increase in the kinetic energy of the particles to anything like the same extent as it is for the more intense collisions which result in absorption. The result would be that the α particles would make far more of these minor collisions before being absorbed at a major one than the particles in the positive rays. We know, for example, from the ionization produced by the α particles that these particles make before they are "absorbed" as many as 100,000 or more collisions. The measurements of Königsberger and Kutschewski (*l. c.*) show that the quantities we have called λ_1 , λ_2 are of the same order as l ; this means that the particles in the positive rays only make a small number of collisions before they are absorbed. Since the change from the uncharged state to the charged one involves the ionization of the gas through which the particles are passing, some energy must be absorbed at these stages, though it need not be more than that corresponding to the ionizing potential of the gas, i. e. a quantity of the order of 10 volts; hence, if a particle were to make as many as ten of these collisions before absorption, the loss of energy would only amount to

some 100 volts, and as the original energy in these rays is generally above 20,000 volts the diminution would have been too small to be detected. The case, however, is very different when we have 100,000 collisions as in the α rays; here the loss of energy is comparable with that possessed initially by these rays.

Wien (*l. c.*) has determined the values of the quantities we have denoted by λ_1 , λ_2 for hydrogen, oxygen, nitrogen, both in the cases when the positive rays were made from the gas through which they passed and also when they were made from different gases. In the case of hydrogen rays passing through hydrogen he finds that λ_1 (reduced to atmospheric pressure on the supposition that it varies inversely as the pressure) is

$$6.15 \times 10^{-5} \text{ cm.}$$

and that $\lambda_2 = 34.8 \times 10^{-5} \text{ cm.}$

The beam of positive rays included both atoms and molecules of hydrogen, so that these values are intermediate between the values of λ for atoms and molecules.

The mean free path of a molecule of hydrogen through hydrogen is according to the kinetic theory of gases 10^{-5} cm. , and that of an atom of hydrogen through molecules of hydrogen about $2 \times 10^{-5} \text{ cm.}$ The values of λ , though greater than the ordinary free paths, are of the same order of magnitude, so that a positive ray particle could not make many collisions of the type of those contemplated in the kinetic theory of gases without altering its electrical state. An interesting point brought out by Wien's experiments is that the values of λ do not seem to depend upon the electro-positive or electro-negative character of the gas. He found that the values of λ when hydrogen positive rays passed through oxygen, which is strongly electro-negative, were much the same as the values when these rays passed through nitrogen, which

has much less strongly marked electrical properties. At first sight it might have been thought probable that the chance of a positive particle being able to take an electron from an electro-negative gas like oxygen would be less than that of its taking one from nitrogen and, therefore, that λ_1 for hydrogen rays through oxygen would be much greater than its value when the rays passed through nitrogen. Wien's experiments show, however, that this is not the case, and, indeed, further consideration would show that we should not expect it to be so; for the ionizing potential for oxygen, which is the measure of the work required to take an electron from a molecule of oxygen, is not greatly different from the ionizing potential of nitrogen. The only effect produced by the electro-negative or electro-positive property of a gas is that in the electro-negative gases like oxygen, chlorine or iodine the negatively electrified constituents in the positive rays are more pronounced than in the other gases. These negatively electrified rays are not by any means confined to the electro-negative elements, for, as we shall see, hydrogen and carbon atoms very often occur with a negative charge.

Let us now consider what occurs in the gas through which the particles in the positive rays are passing when these undergo the transformations we have just been considering.

Let us take first the case when a positively charged particle becomes neutralized. It does so by acquiring an electron from the molecules of the gas through which it is passing. This will result in a molecule of the gas having a positive charge, or if the collision has dissociated the molecule one atom of the gas will be positively electrified and another atom neutral. Whichever view we take the loss of the positive charge is accompanied by the formation of one positive ion in the stationary gas.

Again, when the uncharged particle acquires a positive charge we can see that there must be one negative ion in the stationary gas; this may be either a negatively charged atom or a negatively charged molecule according as the collision which charges the moving particle does or does not produce dissociation.

If the neutral particle acquired a negative charge, as it does in some cases, one positive ion would be formed in the stationary gas. Leaving out of consideration the negatively electrified particles, we see that when a particle in the positive rays has passed once into the uncharged state and back again into the charged state it has produced two ions. Now Seeliger ("Phys. Zeitschr.," 12, p. 839) found that when positive hydrogen rays passed through hydrogen at the pressure of $\frac{1}{100}$ of a millimetre of mercury each particle produced $\frac{1}{3}$ of an ion per cm. of path. This number did not seem to vary much with the speed of the rays. The average distance travelled by a particle between losing its charge and regaining it is $\lambda_1 + \lambda_2$ (see p. 49); taking the values of $\lambda_1 + \lambda_2$ found by Wien we find that at a pressure of $\frac{1}{100}$ of a mm.

$$\lambda_1 + \lambda_2 = 30 \text{ cm. approximately,}$$

so that owing to the transformations from the charged to the uncharged state each particle would produce $2 \times \frac{1}{3} = \frac{2}{3}$ ions per cm. or about $\frac{2}{3}$ of the number found by Seeliger. We must remember that, as we have seen, the rays by these collisions lose only an exceedingly small fraction of their energy, so that their energy is practically intact when they are absorbed. If Seeliger's numbers are right little of this energy can be spent in ionizing the gas; it may perhaps be spent in dissociating the molecules of the gas into uncharged atoms. For, as we have seen, the path the particles travel before being absorbed is quite comparable with $\lambda_1 + \lambda_2$, so that there is a considerable probability of a

particle being absorbed in running through this distance in which it makes only two ions and when the energy it has retained is sufficient to make several hundred ions. If all this energy were spent in ionizing the gas, the number of ions produced by the absorbed rays would be a very large multiple of that calculated on the assumption that there is no absorption. Seeliger's result indicates that it is only five times as much. The subject is one that would repay further investigation.

On many theories of the origin of spectra the emission of series lines is connected with the return of an electron to a positively charged atom, so that the series lines of the gas through which the positive rays are passing would not be excited unless these rays produced some positively charged atoms in this gas. We see from the preceding considerations that when a positively electrified particle loses its charge positively charged atoms are produced in the gas; when however, it regains its charge no such atoms need be produced. Thus, on the theories of the origin of spectra referred to, the positive rays would excite the line spectra of the gas through which they pass when they lose their charge but not when they regain it. This might be tested in the following way: If a pencil of positive rays were sent between two parallel plates, with a large potential difference between them, all the positively electrified particles would be driven against one of the plates, and the beam when it first emerged from the plates would contain nothing but uncharged particles; these would gradually acquire a positive charge, but this process does not excite the series lines of the gas through which they are passing, hence the region traversed by the rays just after they leave the plates ought not to give out the series lines of the gas.

The light given out by the gas through which the particles

pass presumably, since it is a line spectrum, originates from atoms and not molecules. These atoms cannot be moving with velocities at all comparable with those of the particles in the positive rays, for otherwise there would be an appreciable broadening of these lines. Wien ("Ann. der Phys.," 43, p. 955) investigated this point for lines given out by mercury and helium and came to the conclusion that there was no perceptible broadening. He could have detected easily the effect if the atoms giving out the light had possessed velocities of the order they would have acquired by collision with the positive ray particles provided these collisions had been like those between elastic spheres. Hence we conclude that those collisions which result in the absorption of the positive rays do not split up the molecules of the gas into charged atoms. This is in accordance with the conclusions we drew (p. 54) from Seeliger's measurements of the ionization produced by positive rays.

On the other hand the collisions which result in a loss or gain of charge by the positive ray particles, where, as we have seen, the transference of energy from the particles to the molecules is exceedingly small, not only ionize the gas but split the molecules up into atoms.

We should expect that the particle would not be able to lose or gain a charge unless its velocity exceeded a certain critical value, for either of these changes involves the tearing of an electron out of an atom or molecule. When the particle loses its charge the electron is torn from the molecules of the gas through which it is moving, when it regains its charge the electron has to be torn from the particle.

To tear an electron from an atom or molecule requires a finite amount of work, and in the case we are considering this work must be supplied by the moving particle during a collision with the molecule. Since there is little change of

direction in the collisions which charge the molecule, the collisions must be collisions of the particle with an electron, and not with the part of the molecule which furnishes any appreciable part of its mass. Now if a mass M_1 moving with a velocity V comes into collision with a mass M_2 at rest the maximum amount of kinetic energy which can be communicated to M_2 is

$$\frac{4M_1M_2}{(M_1 + M_2)^2} \cdot T$$

where T is the kinetic energy of M_1 before the collision. If M_1 is the mass of a particle in the positive rays, M_2 that of an electron, M_1 will be large compared with M_2 , so that the maximum kinetic energy that can be given to the electron is

$$\frac{4M_2}{M_1} \cdot T$$

and is thus equal to the kinetic energy of an electron moving with twice the velocity of the particle. Thus if the work required to tear an electron from a molecule of hydrogen is measured by 11 volts, which is equivalent to the kinetic energy of an electron moving with a velocity of 2×10^8 cm./sec., a moving atom or molecule could not under the most favourable circumstances eject the electron if its velocity were less than 10^8 cm./sec. In the preceding investigation we have supposed that the electron was free; the result will be modified to some extent if the electron is bound by forces to the massive part of the atom. Indeed, if these forces were infinitely strong the effective mass of the electron might be that of the molecule, and a larger amount of energy might be transferred from the particle to it and the molecule; these collisions would, however, be more akin to those which produce absorption, than to those which produce loss or gain of charge.

The case we have considered is that of the loss of charge

by the particle when it has to tear from the molecules an electron to neutralize the charge—the gain of charge will be affected by similar considerations. Here the molecule has to tear an electron from the particle, and to do so the relative velocity of the two must exceed a definite value depending on the work required to tear an electron from the particle. In the preceding case the limit depended on the work required to tear an electron from a molecule of the gas through which the particle was moving.

We conclude then that a particle will neither lose nor gain a charge unless its velocity is above a certain limit which depends both on the nature of the particle and of the gas through which it is moving. This gives an inferior limit to the velocity of the rays which undergo transformations from the charged to the uncharged state. There will also be a superior limit to the velocity of the particles which pass from the charged to the uncharged state, for though a particle might detach an electron, it could not retain it if the relative velocity of the particle and electron exceeded a certain value.

The ionization we have been considering is that which is produced by collisions which do not appreciably deflect the path of the positive rays, for if these rays suffered any considerable deflections by collisions they could not be recognized on the photographs. It does not follow that to ionize by other types of collision the positive particles need possess velocities approaching the values required when the collisions are restricted to this particular type. We know indeed from the experiments of McClelland ("Proc. Camb. Phil. Soc.," XI., p. 296), Pawlow ("Proc. Roy. Soc.," A. 90, p. 398), v. Bahr and Franck ("Verh. der. Deutsch. Physik Ges.," 16, p. 57) on ionization round positively electrified hot wires that when all types of collisions are operative positive ions can ionize a gas when their energy is that due to a fall through a

voltage very small compared with that necessary to give them velocities comparable with the 10^8 cm./sec., which is the order of the velocity required by the positive rays.

There must, therefore, be ways other than the ones we have discussed by which positive particles can produce ionization, and alternate between the charged and uncharged state. Let us consider, for example, the loss of charge by a positively charged particle. This might occur if the particle in its journey through the gas passed through a molecule of the gas and captured one of its electrons and carried it away with it. Again, a neutral particle passing through a molecule might have one of its own electrons captured and retained by the molecule, and emerge with one electron less, and therefore with a positive charge. We observe that in the first of these cases there is a positive ion produced in the gas and in the second a negative one, in neither case is a free *electron* produced: this distinguishes this process of ionization from that previously discussed. In this process a very high velocity of the particle is not necessary: in fact, if it had sufficient energy to pass through the molecule it would be more likely to capture one of its electrons if it were moving slowly.

We could explain in this way the formation of secondaries by the heavier atoms: the fact that these are exceptional shows, I think, that this method of ionization is not so effective as the other. Another reason for this view is that if the second method took place to any large extent we should expect to find a considerable number of the particles with a negative charge. For consider the case when an uncharged molecule is moving rapidly through other molecules of the same kind: it is supposed to get its positive charge by a stationary molecule capturing one of its electrons, but since the effect depends only on the relative velocity of the two

molecules, it is just as likely that the moving particle should be the one to capture the electron as the stationary molecule, in which case it would get a negative charge. It is, however, only special kinds of atoms which give on the positive-ray photographs any indication of having a negative charge. Again, if any process of this kind occurred in more than a small fraction of the collisions we should expect to get far more ionization by the positive particles than is indicated by Seeliger's experiments. It must not be forgotten that the collisions made by the positive particles in their journey through the gas generate radiations which are able to produce dissociation.

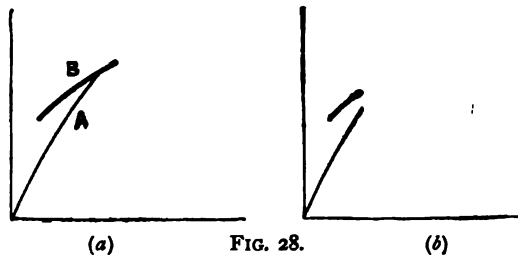
It is important to point out that the collision which ionizes a neutral particle and gives it a positive charge must be a collision with an electron and not with a molecule of the gas through which the positive rays are passing; for the mass of a molecule of the gas is comparable with that of the positive ray particle, hence a collision between the two would result in the particle losing an appreciable fraction of its energy and being deflected through a considerable angle. The appearance and inclination of the secondary lines show that the particles suffer little diminution in velocity in these encounters and no appreciable change in direction, hence we conclude that the system with which the particle collides must have a much smaller mass than the particle, i. e. it must be an electron and not a molecule.

It is to the gain and loss of charge through collision with the molecules of the gas through which the positive rays are moving that we ascribe the origin of the lines we have described on p. 43. We shall call these lines secondary lines and the parabolic ones primary lines.

The type of ionization we have been considering requires the particles to have a velocity comparable with 10^8 cm./sec. ;

the heavier particles could not, however, acquire a velocity approaching this under the potential differences which are usually applied to the tubes used to generate positive rays. We should, therefore, expect that the parabolas corresponding to the heavier elements would not be accompanied by secondaries. This absence of the secondaries to the heavier lines is in general a very marked feature of the photographs. There are, however, exceptions, e.g. the parabola corresponding to CO is accompanied by a secondary even at very low pressure; and Wien has shown that the molecules of oxygen and nitrogen in the positive rays lose and regain the charges when the difference of potential is much less than the amount required to give them a velocity approaching 10^8 cm./sec.

The secondary curves finally join the parabolic arcs produced by the particles which have been charged during the whole of their journey. If the junction occurs at a considerable distance from the head of the primary, care has to be taken in some cases to avoid confusing the secondaries with primaries corresponding to a different value of e/m . Thus, for example, if the shape of the secondary and primary were similar to that shown in Fig. 28*a*, and the point of junction came off the plate, the appearance on the plate would be that represented in Fig. 28*b*, and the secondary might be mistaken



for a primary with a value of e/m less than the true value. If the magnetic field overlapped the electric field on the

camera side of the apparatus, the primary and secondary might resemble Fig. 29*a*, and if the right-hand part were off the plate, the curves would look like Fig. 29*b* and the



(a) FIG. 29. (b)

secondary might be mistaken for a primary with a value of e/m greater than the true value. This possible confusion of a secondary with a primary line is a point which requires careful attention when the curves produced by the positive rays are used to identify the gases in the discharge tube; for this purpose the primary curves are the only ones that can be relied upon. The tests for a primary line are (1) that it is parabolic, (2) that it shows an abrupt increase in intensity at a point in the same vertical line as the heads of the other parabolas. The first condition is theoretically sufficient, but when only short arcs are available it is often difficult, unless a very high degree of accuracy is obtained in the measurement of these lines, to tell whether the curve is or is not a parabola.

We shall see that the study of the photographs gives us further information about the conditions which govern the loss or gain of a charge by the particles in the positive rays.

An interesting feature of these secondary lines is that they are generally sharp and well-defined. Even though the parabolic arc AB which they join may be of considerable length—showing that the velocities of the particles are spread over a wide range—the secondaries do not fill up the whole of the region AOB but are concentrated

along one or more well-defined lines. Most frequently there is a well-defined line from O to A, the point on the parabola corresponding to the particles with the greatest velocity; sometimes, too, there will be in addition another line running from O to another point on the parabola as in the photograph reproduced in Fig. 4, Plate VII. In some cases the secondary to the end of the parabola is wanting and the secondary line joins the parabola at another point. This condensation of the secondaries into lines running to definite points on the parabola is due, I think, to there being a great condensation of the particles in the primary rays round certain velocities, especially round that corresponding to the head of the parabola. This condensation is apt to be obscured when photographic plates which are very sensitive to positive rays, such as Paget or Schumann plates, are used. With these plates a comparatively small number of particles is able to produce the maximum effect, and the result is that the parabolas seem to be of nearly equal intensity along a great part of their length. When much more insensitive plates are used the blackening at the head of the parabola is seen to be in most cases much greater than that at other parts of the arc.

We sometimes see secondaries going from O to a point on the parabola corresponding to the hydrogen molecule and then proceeding, with diminished intensity, up to the parabola corresponding to the hydrogen atom. This indicates that some of the particles which start as molecules of hydrogen split up in their course through the gas into hydrogen atoms.

The view that the secondary lines are connected with great concentration of the particles around certain velocities is confirmed by the fact that when the parabolas have a beaded appearance (see p. 42), and thus indicate considerable concentration round certain velocities, there are apt to be

secondaries running up to the beads in addition to the one to the head of the parabola.

In some cases where there is a fairly uniform distribution of velocities among the particles, the secondaries are not concentrated along definite lines, but are spread over a considerable area. An example of this is shown in Fig. 4, Plate II.

A special type of secondary is shown in Fig. 3, Plate VI. In this case the magnetic field overlapped the electrostatic, so that the equation to the secondary corresponding to a particle with a velocity v will be

$$y = \frac{He}{mv} l' L + x \frac{H}{X} v$$

where y and x are measured parallel to the displacements due to the magnetic and electrostatic forces respectively. H is the magnetic and X the electrostatic force, l' the distance the magnetic field overlaps the electrostatic, and L the distance of the strip l' from the photographic plate. These secondaries, since v varies, form a complex of lines the envelope of which is

$$y^2 = \frac{4H^2 l' L}{X} \frac{e}{m} \cdot x.$$

This is a parabola and is well marked on the photograph. The parabola might have been mistaken for one of the primary ones due to particles with a definite value of e/m ; it can, however, be distinguished from these by the fact that, unlike them, it reaches right up to the origin and has no definite head.

Another point to be noticed is that some kinds of particles give rise much more easily than others to these secondary lines. In general the secondaries are much the most conspicuous with the lightest particles such as those of H or H₂. These particles are the ones which are moving with the highest velocity, and in accordance with the reasons given on p. 57 we should expect that to give rise to secondaries the

particles must be moving faster than a certain critical velocity. The velocities of the oxygen atoms are only one quarter of those of the hydrogen ones, and we can easily understand that while the speed of the atoms of hydrogen might be above the critical velocity that of the atoms of oxygen would be below it, so that we should get hydrogen secondaries but not oxygen ones.

The critical speed required before a particle could lose its charge would on the views expressed on pp. 53, 54 depend mainly upon the gas through which the particles were moving and so would probably not vary much for the different particles in one pencil of the positive rays. The velocity required for a particle to regain a charge depends essentially upon the ionizing potential of the particle, and so would vary from particle to particle in the same pencil.

Either loss or gain of charge may give rise to secondaries, and we have seen how the different types of secondaries may be distinguished, and that unless the magnetic and electric fields are coterminous there may be one secondary for the loss and another for the gain of charge. When the pressure is high both of these may be detected ; at lower pressures this is not in general the case, and I am inclined to think that here the secondaries are all of one type.

This is suggested by the fact that on some plates we find a straight secondary which stops abruptly after going a certain distance and is not joined on to any parabola. Such a plate is represented in Fig. 2, Plate VI. We should get a line of this kind if the particles, for example, could lose but not gain a charge, and if they all lost a charge before they had passed through the electric and magnetic fields. We get ample evidence from the plates that the limiting speed of the particles required to produce secondaries varies with the nature of the particles. Let us take, for example, a very frequent case :

The plate shows the parabolas corresponding to the hydrogen atom and molecule, the atoms of carbon and oxygen, and those corresponding to CO and CO₂. Then, if the pressure is not exceedingly low, we find secondaries corresponding to H₁ and H₂, none corresponding to C or to O or to CO₂, but a well-marked one corresponding to CO, although the velocities of these particles is much lower than those of the atoms of C and O which do not give secondaries. A similar effect is shown by the photograph represented in Fig. 2, Plate II.; when the gas in the discharge tube was exceedingly pure oxygen, the line *a* corresponds to the oxygen atom, the line below it to the oxygen molecule. We see that though the atom line is very strong it has no secondary, while the line corresponding to the molecule has a very pronounced one. I have other photographs where the line corresponding to the oxygen molecule is by far the strongest line on the plate, and yet shows no secondary, while the CO line on the same plate shows a well-marked secondary. Though secondaries to the CO₂ lines are not common they do sometimes occur. Other things being the same, a low ionization potential ought to promote the formation of secondaries. It is worthy of notice that though the line corresponding to the positively electrified oxygen atom may be free from secondaries, the weaker line corresponding to *negatively* charged oxygen atoms shows a well-developed secondary. The loss of charge by a negatively electrified atom merely involves the abstraction from the atom of the extra electron which gives it the negative charge, while the loss of charge by a positively electrified atom involves the abstraction of an electron from the neutral molecule through which the atom is moving; the two processes are quite different, and we should expect the loss of the negative charge to require less energy than that of the positive. The gain of a negative charge by a neutral atom is accomplished

by a process very similar to the loss of charge by a positively electrified one.

Very interesting variations occur in the relative intensities of the secondaries corresponding to the hydrogen atom and hydrogen molecule respectively. In many cases the secondaries for the hydrogen molecule are much more conspicuous than those for the hydrogen atom, indeed on many photographs the secondaries for the molecule are quite strong, while those for the atom cannot be detected. And in others, though some secondaries can be seen reaching the parabola corresponding to the atom, they are prolongations of stronger secondaries to the parabola corresponding to the molecule, and suggest that they arise from particles which began by being molecules but were dissociated into atoms in their path through the gas in the electric and magnetic fields.

Though the secondaries are generally easily distinguishable from the primaries there are not infrequently lines on the plates which require further consideration before their origin can be determined. Such a case is represented diagrammatically in the figure where between the parabolas corresponding to the hydrogen atom and molecule there is a line approximately parabolic and prolonged backwards until it meets the vertical line through the origin. The curved part of this line might be a primary due to a particle with a value of m/e between 1 and 2, the prolongation being its secondary. If this were so the position of this line relative to the H_1 and H_2 lines ought to be independent of the disposition of the electric and magnetic

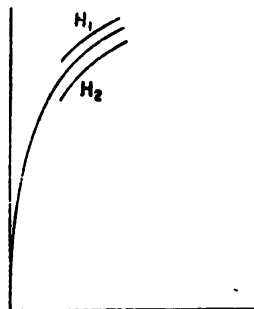


FIG. 30.

fields. This, however, is not always the case; for example, in Fig. 2, Plate VIII. we see on the photograph a line between those corresponding to H_2 and H_3 . When this photograph was taken the electrostatic field was short; on lengthening the field, leaving other conditions the same, this line between 2 and 3 disappeared and another line appeared in a different place. Thus, this line cannot represent an element with an atomic weight between 2 and 3. It is, I think, a secondary differing from the secondaries we have hitherto considered by being curved instead of straight. This curvature can be explained by inequalities in the electric and magnetic fields. Using the same notation as before, let us suppose that the particle does not acquire a charge until it has travelled a distance ξ in the electric and magnetic fields. The y and x displacements when the length l of the field is small compared with the distance L of the photographic plate from these fields are given by—

$$y = \frac{L}{v} \frac{e}{m} \int_{\xi}^l H dz; \quad x = \frac{L}{v^2} \frac{e}{m} \int_{\xi}^l X dz.$$

The secondary on the plate will be the locus of points corresponding to different values of ξ , one point on the curve corresponding to each value of ξ . We have from the equations just given—

$$\frac{dy}{d\xi} = -\frac{Le}{mv} H_{\xi}, \quad \frac{dx}{d\xi} = -\frac{Le}{mv^2} X_{\xi}.$$

$$\text{Thus } \frac{dy}{dx} = \frac{vH_{\xi}}{X_{\xi}}.$$

Thus, if the ratio of the magnetic to the electric force is variable, dy/dx will be variable and the locus will be curved. The sharpness of the line on the photograph indicates that the particles which produce it are all moving with the same velocity, and since from the photographs it is clear that when this curve joins the primary corresponding to the

value of m/e the junction must be far from the head of its parabola, this velocity must be considerably less than the maximum velocity acquired by these particles in the discharge tube. Secondaries of this type, due to the hydrogen atom, would always be less deflected than the primary parabola corresponding to the hydrogen atom, and those due to the hydrogen molecule less deflected than the primary of the molecule.

We have assumed throughout that the electrons which produce the secondaries by neutralizing a positively charged particle or ionizing a neutral one are not the free electrons, but those bound up in the molecules of the gas through which the positive rays are passing. In support of this view the following considerations may be urged. If the electrons were free they would be removed by a strong electric field, and thus the brightness of the secondaries would be diminished by such a field. I have never been able to obtain any evidence of such an effect. Again, as these free electrons would have to be produced by the positive rays, their number would increase with the number of positive rays passing through the gas. As the values of λ_1 , λ_2 (see p. 49) depend upon the density of the electrons, these values would not be fixed merely by the pressure and character of the gas through which the rays passed, the intensity of the stream of positive rays would have an important influence on their values. The determination made by Wien of these quantities are quite inconsistent with this.

In uniform and coterminous electric and magnetic fields the velocity of a particle is proportional to y/x where y is the magnetic and x the electric displacement, thus all particles which have the same y/x have the same velocity. The straightness of the secondary lines shows that all the particles which produce them have the same velocity. Since different

points on these lines correspond to particles which have travelled different distances through the gas before losing their charge, their straightness indicates that there is no considerable loss of velocity by the particles as they pass through the gas.

By means of the formula (3), p. 21, we can calculate v , the velocity of the particles which produce the secondaries, for the hydrogen atom or molecule. The determinations of this kind which I have made make v for the secondaries for the atom about 2×10^8 and for the molecule about 1.3×10^8 cm./sec.

NEGATIVELY CHARGED PARTICLES

We have seen (p. 45) that besides the particles which carry positive charges of electricity there are others which carry negative ones. These negatively charged particles show many analogies with those which produce the secondary rays we have been considering. Like them they are particles which have changed their condition after passing through the cathode. Before they passed through the cathode they were positively charged, and they owe their velocity to the action of the electric field in front of the cathode on this charge. After passing through the cathode they attract first one electron which neutralizes them, and then a second which gives them a negative charge. The attraction which brings in the second electron is one between a neutral particle and an electron. We may compare it to that due to electrostatic induction between an electric charge and a neutral body; the magnitude of this charge depends on the specific inductive capacity of the body and vanishes when this is the same as that of the surrounding medium. It is not surprising, therefore, to find that different kinds of atoms and molecules differ very greatly in their powers of acquiring a negative charge.

The negative components of the positive rays are, in comparison with the positive ones, more conspicuous at high pressures than at low. Thus, for examples at pressures higher than that used for the photographs reproduced in this book we often find the molecule of hydrogen with a negative charge, while at the pressures at which these photographs were taken the negative molecule cannot be detected though the negative atom is nearly always present. Again, the line due to the negative atom of hydrogen is in these photographs faint compared with that due to the positive; at higher pressures, however, I have seen the negative line as strong as the positive.

The electro-chemical properties of the gases play a more conspicuous part in the occurrence of negative constituents than in any other feature of the positive rays. Thus, for example, the atoms of the electro-negative elements oxygen and chlorine are remarkable for the ease with which they acquire a negative charge, and though negative charges occur on atoms of hydrogen and carbon which are not usually regarded as electro-negative, yet there are many gases, e.g. helium, nitrogen, neon, argon, krypton, xenon and mercury of which I have never seen the parabolas corresponding to the negative atom, though those corresponding to the positive atoms have been very strong. Again, negatively electrified molecules, with the exception of those of hydrogen, oxygen and carbon and these but sparingly, have never been detected in the positive rays. The only cases of a molecule of a compound gas occurring with a negative charge which I have observed are those of radicles such as OH , CH_2 ; while molecules with positive charges occur readily enough. The negatives C, CH, O, OH occurred when the gas in the discharge tube was hexane.

We can understand why a positively electrified atom or

molecule is likely to be much more stable than a negatively electrified one. Take the case, for example, of an atom of hydrogen; when the atom is negatively charged it contains two electrons each of which is less firmly held than the single electron in a neutral atom; on the other hand the positively electrified atom does not contain an electron at all. Thus the negatively electrified atom when exposed to violent collisions with other atoms and molecules is evidently more likely to lose its charge than a positively electrified one. Let us consider for a moment the conditions which determine whether a neutral atom in a pencil of positive rays should acquire a positive or a negative charge. It acquires these charges by collisions with the neutral molecules through which it is passing. By the collision the previously neutral positive ray particle acquires a charge of one sign, the neutral molecule against which it strikes one of the opposite. The system which gets positively charged loses an electron, the one which is negatively charged gains one. If one of the colliding systems is much more easily ionized than the other we should expect that this would be the one to lose an electron and acquire the positive charge. Thus, if the gas through which a neutral oxygen atom were moving were helium, which has a very high ionizing potential, we should expect that the oxygen atom would be much less likely to acquire a negative charge, involving, as this does, the abstraction of an electron from the helium, than it would if it were moving through a much more easily ionized gas such as mercury vapour. There is some confirmation of this view, since Wien (*"Ann. der. Phys.,"* 39, p. 539) noticed that the presence of mercury vapour increased the number of oxygen atoms carrying a negative charge; the effect of mercury vapour on the negative hydrogen atoms has not, however, been detected. These considerations suggest that the intensity

of the lines, due to the negatively charged particles, might be affected to a considerable extent by the presence in the gas through which they have to pass of gases which are easily ionized. We have seen that in the case of the loss and gain of charges by the positively charged particles, it is the process of getting rid of the charge which produces positive ions in, and excites the spectrum of, the gas through which the particles are passing. In the case of the negatively electrified ones, however, it is the process of gaining the charge that excites the spectrum of the surrounding gas. Thus, if we could isolate the light due to a pencil of negatively electrified and neutral particles, we should not be able to quench it by driving by means of a strong electric field the negatively charged particles out of the gas, leaving the neutral ones behind.

Though in one sense all the lines on the photographs, which are due to negatively charged particles, are secondaries, different parts of them show differences corresponding to the difference between the primary and secondary positive lines. Some of the negative lines, like the positive secondaries, come close up to the origin, while others, like the primary positives, are finite arcs of parabolas terminating abruptly when they approach within a certain distance of the vertical through the undeflected spot. Indeed the lines on the negative side are sometimes exact reproductions in shape and size of those on the positive. An example of this is shown in Fig. 1, Plate III. The curve at the top on the right corresponds to the hydrogen atom with a positive charge, the lower one on the left to the atom with a negative charge: it will be seen that every detail in the positive curve is reproduced in the negative. This might suggest that the positive and negative atoms were the two halves of a neutral molecule which divided after passing through the cathode. Further

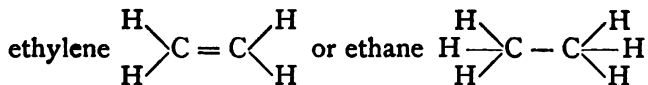
consideration, however, shows that this view is not tenable at any rate in the great majority of cases. The heads of the negative parabolas, like those of the positives, are all on a vertical line, and the distance of this line from the vertical line through the origin is about the same as the corresponding distance for the positive parabolas. It follows from this by equation (2), p. 21, that the maximum value of the kinetic energy of the particles is about the same for the negative as for the positive particles. It is generally a little less, but the difference is not large. Now, to take a definite case, let us suppose that the negative hydrogen atom owes its charge to having been in chemical combination with, say, an atom of carbon before passing through the cathode, the molecule of the compound having been positively charged when in the discharge tube and thus acquiring a high velocity under the electric field. After passing through the cathode the molecule loses its charge, and then dissociates into a positively charged carbon atom and a negatively charged hydrogen one. The kinetic energy acquired by the molecule CH , if it had one charge of electricity, would be measured by V , the potential difference between the anode and cathode in the discharge tube. Since the mass of the carbon atom is twelve times that of the hydrogen one, the kinetic energy possessed by the latter would be measured by $V/13$, so that if this atom went through the same electric and magnetic fields as the carbon atom, the horizontal deflection of the hydrogen atom would be twelve times that of the carbon one. The photographs show, however, that these deflections are nearly equal. Thus the view that the negatively charged atoms arise from the dissociation of rapidly moving neutral molecules cannot be reconciled with the results of experiment. The results, as far as they are known, are in accordance with the view that the negatively charged atom began as

a positively charged one, and then captured two electrons in succession, and thus became negatively charged. Even though a neutral atom or molecule managed to knock an electron out of a molecule with which it came into collision, it does not follow that it would be able to capture the electron : to do this the neutral atom must exert considerable attraction on the electron. The magnitude of the attraction between a neutral atom and an electric charge must, if we regard the atom as made up of electrons and a positive charge, depend on the freedom with which the electrons can move under a force exerted by an electron outside ; if they can move readily the attraction may be considerable, if, on the other hand, they are rigidly connected with the atom it will be very small. A very simple experiment will illustrate this point. Suppose we have a considerable number of small compass needles with agate caps placed on a disc which is suspended from a long string. If we mount the compasses so that they can turn freely on needle points fixed to the disc, and then hold a magnet near the disc, the disc will be strongly attracted by the magnet. If, however, we take the compasses off the needle points and lay them on the disc the friction will prevent any motion relative to the disc, and when the magnet is placed in the same position as before the attraction will be found to be very much reduced.

Thus we should expect the attraction between a neutral atom and an electron to be much increased by the presence in the atom of electrons which can move freely relatively to the atom. If these freely moving electrons are those which are near the surface, and which give rise to the forces which bind the atoms in a molecule together, we can understand why a neutral molecule should not attract an electron as vigorously as a neutral atom. For when two atoms in a molecule are held together by the forces between

their electrons, the electrons in each atom will take up definite positions in the atoms and will resist any displacement. Their mobility will thus be diminished and they will not exert so much attraction on a charge of electricity outside the molecule. It is remarkable that, so far as we know, the atoms of the monatomic gases never occur with a negative charge in these experiments; this is consistent with the preceding theory, for the existence of the molecule depends on one of its atoms being able to grip one or more of the electrons of the other, thus one of the atoms must be able to hold a negative charge.

The properties which prevent an atom in the positive rays from acquiring a negative charge are operative in the general case of ionization, produced by such agents as Röntgen rays, ultra-violet light, etc. For Franck ("Verh. d. Deutsche. Phys. Gesell.," 12, 613, 1910) has shown that in these cases gases such as argon and nitrogen, which are never found with negative charges in the positive rays, exert so little attraction on the electrons that these remain free after having made large numbers of collisions with the molecules of the gas. The circumstances under which the *molecule* of carbon acquire a negative charge are of considerable interest. When the carbon compounds in the discharge tube are such as CH_4 , CO or CO_2 , where there are no bonds between the two carbon atoms in the molecule we get negatively charged carbon atoms but no negatively charged molecules. When, however, we have compounds such as acetylene $\text{H}-\text{C}\equiv\text{C}-\text{H}$,



where according to the usual interpretation of the constitution of these substances there are bonds between the carbon atoms in the molecule, we find *molecules* as well as atoms of carbon

with a negative charge. This is a very interesting result, as it shows (1) that there are strong forces between two carbon atoms in a molecule of the compound, forces strong enough to keep them together when the compound molecule is split up; (2) that the electrons in the constituent atoms of the carbon molecule have considerable mobility, i. e. that the pair of carbon atoms are not saturated in the same way that the pair of atoms in the molecule of nitrogen, for example, are saturated. These conclusions are in good agreement with chemical theory. With benzene vapour in the discharge tube I have found, in addition to negatively charged carbon atoms and molecules, negatively charged triplets containing three carbon atoms. I have sometimes thought that in this case I could see indications of a line corresponding to four carbon atoms with a negative charge, but the line has been so faint that I cannot be sufficiently certain of the accuracy of the measurements to be quite sure that it was due to C_4 .

ATOMS CARRYING TWO OR MORE POSITIVE CHARGES

Though the heads of most of the parabolic arcs are situated in the same vertical line, in many cases some of the parabolas, especially those corresponding to the atoms of oxygen and carbon, are prolonged towards the vertical axis. The prolongations do not reach right up to this axis, but in many cases, as in the line a in Fig. 2, Plate II., which is due to the atom of oxygen, stop after going half-way. These prolongations of the parabolas are also parabolic and are continuations of the primary parabola. They are therefore due to particles which, when they are in the deflecting fields, have the same value of e/m as the particles which produce the primary parabolas. The fact that the smallest horizontal deflection of the prolongation is just half that of the

corresponding deflection of the primary shows (see p. 21) that the swiftest of the particles in the prolongation has twice the kinetic energy of the swiftest in the primary. Thus these particles when in the electric field in the discharge tube acquire twice the kinetic energy of the normal particle; they must therefore when in the discharge tube have had twice the normal charge. They must, after passing through the cathode and before getting into the deflecting fields, have had their charge reduced to the normal value. For, as we have seen, the value of e/m in these fields is normal, hence if they have retained the double charge they must have double the mass. If, however, they had retained the double charge the electrostatic deflection would have been normal: for though the kinetic energy is doubled, which halves the deflection for normal charge, the charge and therefore the electrostatic deflection for given kinetic energy is doubled too, and hence the result would be the normal deflection, while the actual deflection is only one-half of this. We conclude, therefore, that the prolongation is due to particles which had a double charge when in the discharge tube, but which have lost one of these charges after passing through the cathode.

It is a strong confirmation of this view that when we find these prolongations we generally find on the same plate parabolas with their heads in the normal place giving a value of e/m twice that given by the line with the prolongation; these are due to particles which have retained their double charge after passing through the cathode. And conversely when the lines corresponding to the double value of e/m are present we find a tail or prolongation to the line corresponding to the normal value. This would not necessarily be true at pressures so low that the particles did not make any collisions after passing through the face of the cathode, but I have not been able to reduce the pressure to this point.

The prolongations of the parabolas in some cases extend much more than half-way to the vertical axis; this is especially the case with the parabola produced by the positively charged atom of mercury. Fig. 3, Plate II., shows that even when the electric and magnetic fields are strong enough to produce several millimetres deflection in the heads of the parabolas corresponding to the other elements the head of the mercury parabola is so little deflected that at first sight it seems to coincide with the origin. When exceedingly large electric fields are used it can be seen, however, that the head of the mercury parabola is distinctly displaced, and on measuring the amount of the deflection it is found to be one-eighth of the normal displacement of the heads of the parabolas corresponding to the other elements.

This, as we have seen, implies that the particles which produce the head of the parabola corresponding to the atom of mercury must have eight times the maximum amount of energy possessed by the normal atom; if the theory given above is true, this means that some of the mercury atoms had, before passing through the cathode, eight times the normal charge, i. e. had lost eight electrons. Eight is a very large number for an atom to lose, so that if in this case we can obtain independent evidence of such a loss it will be a strong confirmation of the theory.

A study of plates taken with large electrostatic deflections has revealed the existence of seven parabolas due to mercury, corresponding to the mercury atom with 1, 2, 3, 4, 5, 6, 7 charges respectively. The parabola corresponding to eight charges has not been detected, but as the parabolas in general get fainter for each additional charge, it is probably on the plate, although not intense enough to be visible. Fig. 4, Plate II., taken from a photograph when the gas in the tube was the residual gas left after exhaustion by the Gaede pump,

shows these lines very well. The measurements of m/e for the parabolas on this plate give the following value (m/e is taken as unity for the atom of hydrogen)—

m/e	
200	200/1
102	200/2
66.3	200/3
50.4	200/4
44	this is not a mercury line but is due to CO_2
39.8	200/5
33.7	200/6
28.6	200/7.

It will be noticed that the heads of the parabolas corresponding to 1, 2, 3 . . . charges respectively lie on a straight line passing through the origin. This shows (p. 21) that the particles which produce these heads are all moving with the same velocity, and therefore, since each particle is an atom of mercury, that the kinetic energy of the particles at the heads of the parabolas is constant. This is in agreement with the theory, for the heads of all the parabolas are due to particles which before passing through the cathode had lost eight electrons. The particles at the head of the parabola corresponding to one charge ($m/e = 200$) has regained seven of these after passing through the cathode; the one at the head of the parabola corresponding to two charges ($m/e = 100$) has regained six, and so on. As the charge on these particles when they were in the discharge tube was eight units in each case, they would naturally acquire the same amount of kinetic energy before passing through the cathode.

The question now arises as to how the mercury atom acquires these very various charges. Can an atom of mercury when ionized lose any number of electrons from one to

eight, or does it always lose a definite number? Take for example a mercury atom with five positive charges: has it got into this condition by losing five charges when it was ionized, or did it originally lose the maximum number eight and regain three subsequently? The photographs suggest, I think, that the second supposition is the correct one, and that in the discharge tube there are two, and only two, kinds of ionization. By one of these the mercury atom loses one electron, by the other eight. The evidence for this is as follows: let us suppose for a moment that atoms with any charges from one to eight were produced by the ionization of the atoms of mercury in the discharge tube, and consider what effect this would have on the parabola corresponding to the mercury atom with one charge. This would be due to atoms of the following kinds—

Atoms which had lost

(1)	8	electrons	in	the	discharge	tube	and	regained	7	subsequently
(2)	7	"	"	"	"	"	"	"	6	"
(3)	6	"	"	"	"	"	"	"	5	"

and so on: the last member of the series being atoms which had lost one electron on ionization and had not regained it.

The parabola seen on the plate would be due to the superposition of the eight parabolas due to these different types of atoms. The head of each of these parabolas would be separated from the head of any of the others: if d were the horizontal deflection of the one due to the atom which had only lost one electron in the discharge tube, $d/2, d/3, d/4, d/5, d/6, d/7, d/8$ would be the horizontal deflection of the heads of the parabolas due to the atoms which had lost 2, 3, 4, 5, 6, 7, 8 respectively. Thus the resultant parabola would, for the part which had a horizontal deflection between $d/8$ and $d/7$, consist only of the parabola due to atoms of class (1); the part when the horizontal deflection was between $d/7$ and $d/6$

would consist of two parabolas due to the atoms of classes (1) and (2); the part with the horizontal deflection between $d/6$ and $d/5$ would be made up of the three parabolas corresponding to the atoms belonging to classes (1), (2), (3), and so on. Thus at the distance $d/7$, $d/6$, $d/5$, $d/4$, $d/3$, $d/2$ and $d/1$ we should expect an abrupt increase in the brightness of the curve, for at each of these places a new parabola is added to the old ones; the intensity of the curve would thus not vary continuously but would have a beaded appearance. The abrupt increase in intensity at the distance d is very marked in the parabola; it is, however, the only one to be detected. The intensity of the parabola corresponding to the atom with one charge is very great, and it might be thought that the charges in the intensity might escape detection owing to the breadth of the curve. We may, however, apply the same reasoning to the parabolas which correspond to mercury atoms with three or four charges which are fine and well defined. The intensity of these curves is, however, perfectly continuous and there are no signs of the abrupt variations which ought to occur if the mercury atoms in the discharge tube had charges intermediate between one and eight. This result suggests that the ionization is mainly at any rate of two types, in the one type an atom of mercury loses a single electron, in the other it loses eight. There would thus seem to be two different agents producing ionization in the discharge tube.

The maximum number of charges carried by a multiply charged atom does not seem to be related to any chemical property of the atom such as its valency, but to depend mainly on the atomic weight; thus mercury, the most massive atom on which observations have been made, can have as many as eight charges, krypton atomic weight (82) four or five, argon atomic weight (40) three, neon atomic

weight (20) two, nitrogen atomic weight (14) and oxygen (16) two, perhaps in rare cases three, helium also occurs with two charges; the multiple charge has been found on the atoms of all elements tested with the very suggestive exception of hydrogen: no hydrogen atom with more than one charge has ever been observed, though as the hydrogen lines occur practically on every plate more observations have been made on the hydrogen lines than on those of any other element.

When there are on the plates lines corresponding to atoms of the same element with one, two, three charges, then the larger the number of charges the fainter the line. Judging from the intensity of the lines we should conclude that the number of multiply charged atoms is only a small fraction of the number with one charge. The ratio of the number of atoms which have only one charge to that of those which have two or more charges is very variable and depends on conditions which are not yet fully understood. For example, in the case of the carbon atom this ratio seems to depend to a very great extent on the type of gaseous carbon compound in the discharge tube. With some hydrocarbons the doubly charged carbon atoms are relatively much brighter than with others. Again, in the case of oxygen I have found that the purer the oxygen the fainter was the line due to the doubly charged oxygen atom in comparison with that due to the atom with only one charge. It would thus seem that atoms torn from chemical compounds were more likely to have a double charge than those obtained from a molecule of the element. Chemical combination cannot, however, be the only means by which the atoms acquire multiple charges, for the atoms of the inert monatomic gases, neon, argon and krypton, are remarkable for the ease with which they acquire multiple charges.

Though double charges occur so frequently on *atoms*, they are exceedingly rare on *molecules*, whether of elementary or compound gases. They do sometimes occur, as the line corresponding to $m/e = 28$, which may be due either to a molecule of nitrogen or of carbon monoxide, has on many plates a prolongation towards the vertical axis, implying a double charge on the molecule.

CONCENTRATION OF THE POSITIVE RAYS ROUND DEFINITE VELOCITIES

The parabolas are not always of even approximately uniform intensity along their arcs, but sometimes, as in those represented in Fig. 3, Plate I., Fig. 3, Plate II., Fig. 2, Plate III., show abrupt increases in intensity at definite points along the arc. These increases are often comparable with that which occurs at the head of the parabola. In some cases, indeed, as in the line for the hydrogen molecule in Fig. 1, Plate III., the second maximum is much greater than the one at the head of the parabola. The position of the second maximum is generally connected with that of the first—the one at the head of the parabola—by the very simple rule that the electrostatic deflection of the head of the second maximum is twice that of the head of the parabola. This means that the kinetic energy of the particles forming the second maximum is half that of those forming the first.

It is an interesting point that in the great majority of gases when the photographic plate shows parabolas corresponding to both atoms and molecules, the "beaded" appearance due to the existence of these maxima is confined either to the atomic or to the molecular lines, the beading does not occur on all the lines. If the line due to the atom of one element is beaded, those on the same plate due to the atoms of other elements are also beaded, while if the

line due to one molecule is beaded those due to other molecules are often beaded too. The lines due to the monatomic elements show beading when either the atomic or molecular lines of the diatomic gases are beaded, thus the atoms of the monatomic elements can in this respect behave like either the atoms or the molecules of a diatomic gas.

We should expect to get a concentration of the positive rays about particular energies if in front of the cathode there was a maximum of ionization, not only at the boundary of the dark space but also at another place P between this boundary and the surface of the cathode; then if V_1 were the cathode fall in the dark space, V_2 that between the cathode and P, we should have concentration of the positive rays about the energies V_1 and V_2 . With curved cathodes where the cathode rays are brought to a focus it is possible that such an effect may exist, but the very simple relation that exists between the energies in the two maxima, viz. that one is twice the other even though the shape of the cathode may undergo wide variations, suggests a different explanation.

Let us take first the beading on a line due to a charged atom. The line due to the hydrogen atom, for example, often shows an increase of intensity at b , where the energy of the particles is half that at a the head of the parabola. This would be the case if the atoms at b were due to the breaking up of molecules after they had passed through the cathode. The molecules would have acquired in the discharge tube energy equal to that possessed by the atoms which strike the plate at a . When they broke up after getting through the cathode and before reaching the electric and magnetic fields, this energy would be divided between the two atoms; each atom would have one-half of the energy, one atom would have the positive charge previously on the molecule, this atom would strike the photographic plate at b , the other

atom would be electrically neutral and would strike the plate at the undeflected spot.

As this type of beading is observed on the parabolas due to the mercury and helium atoms, we must suppose that, although mercury and helium are monatomic, their positively charged atoms can unite with a neutral one to form a system sufficiently stable to hold together while moving through the dark space in front of the cathode, though not stable enough for an appreciable number of them to get through the fields of electric and magnetic force, for if they passed through these fields lines corresponding to the helium molecule would be found on the plate. The line corresponding to the mercury molecule is found occasionally. The maxima on the parabolas corresponding to molecules could in a similar way be explained as arising from systems which before reaching the cathode consisted of a pair of molecules, one singly charged and the other uncharged, the system breaking up after passing through the cathode.

They could also be explained if, instead of a two-molecular system breaking up, a molecule was formed by the union of an atom which had come through the dark space and acquired the energy due to the fall of potential between the anode and cathode with an uncharged atom at rest; the collision which produced this union being analogous to that between two equal unelastic bodies where the velocity of the system after impact is half that of the moving body before, and the kinetic energy of the system consisting of the two bodies half that of the moving body before impact.

Though, as far as my experience goes, the energy of the particles in the second maximum is most frequently one-half of that in the primary, this is not invariably the case. I have some plates where the ratio of the energies for the hydrogen molecule is two-thirds and not one-half. This case

could be readily explained by the splitting up of a system H_2 into a charge molecule H_2^+ and a neutral atom; a result supported by the fact that on the plates showing the parabolas when this ratio obtains there is a parabola corresponding to the system H_2 .

This view of the origin of the beading on the atomic lines receives great support from some experiments I made when the gas in the tube was CO. If the molecule of CO were to split up after passing through the cathode the carbon atom would have $12/28$, and the oxygen one $16/28$ of the normal energy: thus these atoms would appear on the plate with electrostatic deflection $28/12$, and $28/16$ of that of the heads of the parabolas. On the line corresponding to the carbon atom on some of the plates there was a bead at 2.3 times the horizontal distance of the head, and on the line corresponding to the oxygen line one at 1.7 times this distance; they are thus almost in exactly the positions predicted by the theory. The beading occurred on both the positive and negative parabolas for these atoms.

Sometimes the maxima are much closer together than in either of these cases. I have some plates, for example, where the ratio of the energies is as 7 to 9. Cases like this could be explained by a heavy molecule shedding some of its lighter atoms. Thus, for example, if a molecule CH_4 were to break up after passing through the cathode into CH_3 and H , there would on the line representing CH_3 be a maximum where the energy equalled $14/16$ of that of the primary compound. I do not think, however, that the maxima which lie so close together can be explained in this way, for we find that when the ratio of the energies for one line is 7 : 9 it has the same ratio for the other lines, whereas, if it were due to the splitting up of molecules we should expect the ratio to vary with the molecular weight. I think that when

the ratio of the energies is so nearly unity as this, the beading is probably due to some sudden change in the pressure in the discharge tube producing a sudden change in the potential difference between anode and cathode, and thus altering the maximum energy which can be acquired by a charged particle when it passes through the dark space in front of the cathode. The lines corresponding to atoms with two charges sometimes show a second maximum where the energy is half that corresponding to the primary one. This, I think, indicates that some of the atoms which when passing through the electric and magnetic fields have a double charge, had only one charge when they passed through the dark space and were under the influence of the electric field in the discharge. They acquire another charge (i. e. lose another electron) after passing through the cathode and before entering the electric and magnetic fields.

ON THE ORIGIN OF THE CHARGED ATOMS AND MOLECULES IN THE POSITIVE RAYS

The positive rays consist of a great variety of constituents ; some of these are positively charged atoms, others positively charged molecules, both of elements and of compounds. We propose now to consider how it is that some of the carriers are atoms while others are molecules. In the first place a study of the photographs, or, what is even better, measurements of the number of particles of different types by the method described on p. 120 shows that the proportion between the number of atoms and molecules in the positive rays is subject to very wide variations, and depends to a very great extent on such things as the pressure of the gas, the size and shape of the cathode and its position in the discharge tube. Examples of this variation in the relative intensities of the lines, due to the atoms and molecules of hydrogen, are

shown in Figs. 3 and 4, Plate III. In Fig. 3 the line due to the hydrogen atom is quite strong, while that due to the molecule is too faint to be seen in the reproduction of the photograph; in Fig. 4, on the other hand, it is the line due to the molecule which is strong, while that due to the atom cannot be seen in the figure. As a general rule the lines due to the molecules are more important relatively to those due to the atoms the lower the pressure of the gas in the discharge tube and the greater the potential difference between the anode and cathode. This effect of pressure is probably the explanation of why the proportion between

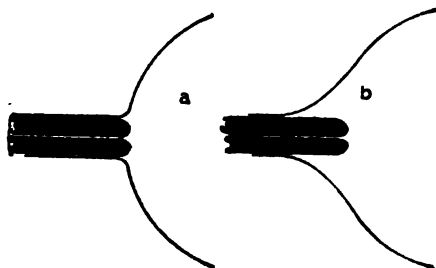


FIG. 31.

the atoms and molecules depends on the position of the cathode in the discharge tube. If, for example, the cathode is placed so that the front of the cathode comes inside the neck of the discharge tube, as in Fig. 31*a*, the atomic line of hydrogen is stronger than the molecular; it is weaker, however, when the face of the cathode protrudes into the discharge tube, as in Fig. 31*b*. The pressure at which the positive rays are at their best is higher in the first case than in the second, so that the effect of pressure would be sufficient to explain this effect. It would also explain why the molecular lines should be relatively more conspicuous in large tubes than in small ones. Again, when the discharge tube is, like a Röntgen-ray tube, provided with an anticathode against which the cathode rays strike, the proportion between the

intensities of the atomic and molecular lines depends on the position of the anticathode and also upon whether it is insulated or connected with the anode. The potential difference in the tube is also affected by these changes. As a general rule, if the line due to the molecule is stronger than that due to the atom for one element represented on a photograph, it will be so for the other elements. Let us now consider the various agents at work in the discharge tube in giving a positive charge to the particles which constitute the positive rays.

These are—

1. High-speed cathode rays.
2. Secondary cathode rays with a much lower speed.
3. The positively electrified particles themselves.
4. The retrograde rays (see p. 134). These carry a negative charge and have masses comparable with those of the positively electrified particles.
5. Radiant energy of small wave-length arising from the impact of the high-speed cathode and positive rays against the molecules of the gas in the tube, the walls of the tube and the electrode. These impacts detach electrons from the molecules, and the falling into the molecules of electrons to take the place of those ejected gives rise to radiation which can ionize the gas.

Let us take these ionizing agents in order and consider whether they produce charged atoms or charged molecules.

The high-speed cathode rays, since they penetrate into the atom and come into contact with the individual electrons, would in general give rise to singly charged systems; a priori, we should expect that these systems would be molecules rather than atoms, except when the electrons which the cathode rays struck against and ejected were those which

bound the two atoms in a molecule together. In this case the disruption of the bond between the atoms might lead to the disruption of the molecule.

The direct evidence we possess on this point is derived mainly from observation on the nature of the spectra excited by cathode rays. As line spectra are usually associated with atoms, if the cathode rays excite the line spectrum of a gas through which they are moving, it would be strong evidence in favour of their power to dissociate a molecule into atoms. The spectra produced by cathode rays have been investigated by Wüllner (*"Phys. Zeitsch.,"* 1, p. 132, 1899), Lewis (*"Astrophysical Journal,"* 17, p. 258, 1903), and also by Fulcher (*Ibid.*, 34, p. 388, 1911), who comes to the conclusion that the spectrum of the light produced by cathode rays (1) in nitrogen consists solely of the negative bands; (2) in hydrogen consists chiefly of the compound spectrum together with the main series lines which are relatively weak; (3) in oxygen consist of the negative bands together with the spark lines and series of triplets. These results agree in general with those obtained by Wüllner and Lewis. They are consistent with the view that while the cathode rays do produce some dissociations of the molecules into atoms, the chief part of the light comes from the molecules: so that if cathode rays were the only source of ionization in the discharge tube we should expect that the number of charged molecules in the positive rays would exceed greatly the number of charged atoms. We may remark that the production of "single line spectra" by cathode rays, when various metallic vapours such as mercury, magnesium and cadmium emit special lines under the impact of comparatively slow cathode rays is not a case in point, as these vapours are monatomic, so that there is no question of dissociation. The bombardment of salts by cathode or positive rays gives rise to luminosity, and the marked differences between the nature of the light, in the two cases

favour the view that the cathode rays are not efficient in splitting molecules up into atoms. If, for example, lithium chloride is bombarded by cathode rays it shines with a blue phosphorescence and the spectrum is a continuous one; when it is bombarded by positive rays the phosphorescence is red and the spectrum shows the lithium lines.

Since the ionizing power of cathode rays, when their velocity exceeds a certain value, diminishes rapidly as the velocity of the rays increases, the secondary cathode rays in the discharge may produce more ions than the primary fast rays. We have no reason, however, for believing that they would be more effective in splitting up molecules into atoms.

We now come to the positively charged particles. The spectroscopic evidence seems to leave little room for doubt that these are very effective in producing dissociation of molecules into atoms, for when the positive rays pass through a gas they cause it to emit a line spectrum. This is shown most clearly when the gas through which the electric discharge passes is different from that through which the positive rays pass after getting through the cathode. This occurs when the only connection between the region where the discharge takes place and that where the spectrum is observed is a long, narrow tube through which the positive rays pass; we can then have different gases in the two regions without much mixing, and in this case the spectrum shows the lines of each of the gases. The emission of light by the positive rays will be considered more fully in a subsequent chapter, but from what we have seen it is evident that in the positive rays themselves we have the means of producing the atoms which are observed in the positive rays. The question arises: Do the positive particles produce nothing but charged atoms, and have we to attribute all the positively charged molecules to the cathode rays? The following experiment suggests, I think, that this is not

the case, and the cathode rays do not produce directly the greater part of even the charged molecules. For if the charged molecules were due entirely to the cathode rays, if we deflected the cathode rays in the discharge tube to one side so that they no longer passed through the column of gas just in front of the hole in the cathode, we should expect to diminish the number of charged molecules compared with charged atoms. I have made observations on this point using the lines due to the atom and molecule of hydrogen for this purpose. I found that the cathode rays might be deflected to a considerable extent before any very great diminution in the intensity of the positive rays set in; and that as long as I could observe the rays there was no diminution in the intensity of the lines due to the molecule as compared with those due to the atom.

The mechanism by which a molecule is dissociated into atoms is a subject of great interest and one about which there is much uncertainty. The most obvious view of the way the positive particles split a molecule up into atoms is that the positive particle, by its impact with the molecule, gives to one of the atoms in the molecule sufficient kinetic energy to enable it to escape from its companion. The objections to this explanation are (1) that if the particles came into collision with masses as great as those of an atom they would be deflected through an appreciable angle and would lose a considerable amount of their energy. We have seen, however, that until the collision occurs which produces their final absorption they do not suffer any appreciable deflection or loss of energy by the collisions. Another objection is that, on this view, the atoms struck by the particles would, after the collision, have a finite velocity, so that the Doppler effect would produce a broadening of the lines in the spectrum of the gas through which the positive rays pass. Wien looked for this effect but was not able to

find it. These results indicate that if the dissociation is produced by the collisions these must be between the positive rays and the electrons which bind the atoms together, and not with the massive parts of the atom.

The difficulties which stand in the way of explaining dissociation by collisions are not confined to the case of the positive rays. They exist, as I pointed out many years ago ("Phil. Mag.," 18, p. 233, 1884), in the case of ordinary thermal dissociation such as that which occurs when iodine vapour is heated. For when equilibrium is reached the number of molecules split up per second in unit volume must equal the number of molecules formed by the re-combination of the atoms. If m is the number of molecules per unit volume the number of collisions in unit time per unit volume will be proportional to m^2 , and if the dissociation of the molecules is due to collisions the number of molecules dissociated will also be proportional to m^2 . Again, the re-combination of the atoms results from the collisions between the atoms, and the number of such collisions per second in unit volume is proportional to n^2 , where n is the number of atoms in unit volume. Hence the number of molecules formed in one second in unit volume is proportional to n^2 , and the number split up proportional to m^2 . When the system is in a steady state these numbers must be equal, hence m^2 must be proportional to n^2 , or m proportional to n . We know, however, that m is not proportional to n but to n^2 . So that it would seem that in this case the splitting up of the molecule into atoms is not due to the knocking of the molecules against each other. This objection would not apply if dissociation did not take place throughout the gas but only at the walls of the vessel in which it is contained. I suggested in the paper referred to above that the dissociation might be brought about by the radiant energy which passed through the gas, and whose quantity and quality is a known function of the temperature.

When the dissociation is due to an external agent like this the number of molecules dissociated in unit volume in unit time would be proportional to m and not to m^2 , and when the steady state was reached we should have m proportional to n^2 , which is the relation which does exist between these quantities. The simplest way of picturing this effect of radiation is to suppose that some period of the vibrations of the electrons which bind the atoms in the molecules together, coincides with the period of the radiation, or when this is complex of some constituent of it. Then, owing to resonance these electrons will absorb a considerable amount of energy, enough it may be to enable them to get free from the molecules and leave the atoms which they bound together disconnected. When the radiation is like that of a black body the energy in the radiation of frequency between n and $n + dn$, is proportional to

$$\frac{\epsilon^{-hn/R\theta}}{1 - \epsilon^{-hn/R\theta}} n^3 dn$$

where h is Planck's constant, θ the absolute temperature and R the gas constant. If n is the frequency of one of the electrons, w the work required to liberate it, then if we assume Planck's law $w = hn$; and the energy in the radiation in tune with the binding electrons would thus be proportional to

$$\frac{\epsilon^{-w/R\theta}}{1 - \epsilon^{-w/R\theta}} w^3 dw$$

Hence we should expect that the rate at which the molecules are split up into atoms would when considered as a function of the temperature be proportional to

$$\frac{\epsilon^{-w/R\theta}}{1 - \epsilon^{-w/R\theta}}$$

This when the temperature is low enough to make $R\theta$ small

compared with w would be approximately equal to $\varepsilon^{-w/R\theta}$ and the results of experiments on dissociation are in accordance with this law of variation of temperature. Thus the view that the dissociation of molecules into atoms is often produced by the effect of electromagnetic waves receives some support from the phenomena of thermal dissociation. If we suppose that the particles in the positive rays are emitting such waves, not necessarily of a definite period, but covering a considerable range of periods, then the dissociations which they produce when they pass through the gas might not be due to collisions between the molecules and what may be called the body of the particles in the positive rays, but rather between the molecules and the electromagnetic field round the particles.

If radiant energy is an efficient means of dissociation then the radiations in the discharge tube may be the origin of some of the atoms which are produced in the positive rays before they reach the cathode. Radiation analogous to soft Röntgen radiation, which possesses great powers of ionization, is a very usual, perhaps an invariable, accompaniment of an electric discharge through gases; the *Entladungstrahlen* investigated by Wiedemann and others form a part of this radiation. It seems not unlikely from the considerations given above that this radiation may be able to produce a type of ionization where the molecules are dissociated into atoms.

The only type of ionizing agent in the list on p. 90 which remains for consideration is the retrograde rays. These rays are particles similar to those which form the positive rays but carrying for the most part a negative instead of a positive charge, and moving in the opposite direction to the positive rays. As far as ionization and dissociation go, they

might be expected to behave in much the same way as the positive rays.

Let us now consider the places in front of the cathode where these agents might be expected to be most active. Let us take first the high-speed cathode rays. These seem to acquire a high velocity close to the cathode. Such ionization as they can produce may be expected to occur from the cathode right up to where they strike against the walls of the discharge tube. It is not, however, probable that any large fraction of the ionization in the tube is due to the direct action of these rays. The amount of ionization due to such rays has been measured by Glasson ("Phil. Mag.," Oct. 1911), who found, as is indicated by theory, that the number of ions produced by a cathode ray per unit length of its path varies inversely as the kinetic energy of the ray. For rays moving with a velocity of 4.7×10^9 cm./sec. through air at a pressure of 1 mm. of mercury he found that 1.5 pairs of ions were produced by each ray in travelling over 1 cm. Under the usual conditions for the production of positive rays the velocity of the high-speed cathode rays is considerably greater than 5×10^9 cm./sec. This would reduce the ionization if the pressure remained the same, but the pressure of the gas in positive ray experiments is generally less than .01 mm., so that even if we neglect the diminution in ionization due to increased velocity, a cathode ray in the positive ray experiments would only produce 1.5 pairs of ions when it had travelled over a metre, a distance much greater than the length of the tube. We conclude that the ionization in the gas is not in the main due to high-speed cathode rays.

Let us now consider the low-speed cathode rays. The positive ions from the negative glow, when they get into the dark space, soon acquire sufficient energy to ionize the

gas, producing electrons and positive ions. These electrons will at first move slowly, as they are in the region in the dark space where the electric field is comparatively weak; as their velocity is small they will be efficient ionizers and will give rise to other electrons; these will start in a still weaker field and become still more efficient ionizers, as it is not until the velocity of the electrons sinks below that due to a fall through about 200 volts that the ionization due to these particles increases as their velocity increases. Thus the number of these slowly moving cathode rays will increase with great rapidity near the anode end of the dark space, and the ionization and dissociation, and therefore the positive rays due to them will be a maximum in this region. As the positive rays which start from the boundary of the dark space on the anode side have fallen through the whole potential difference between the anode and cathode, they will have the maximum velocity when they pass through the cathode, and will hit the photographic plate at the heads of the parabolas. Thus if all the charged molecules in the positive rays were due to the slow cathode rays, or came out of the negative glow, we should expect the molecular lines to be short, or, at any rate, to have a well-marked maximum of intensity at the head of the parabola.

Let us now consider the effect of the positive rays themselves. The energy of these when they are near the negative glow will be small and will increase as they move towards the cathode, their number too will increase in consequence of fresh ionization; thus the ionization due to the positively charged particles will increase towards the cathode. The particles produced near the cathode will only fall through a part of the potential difference between the anode and the cathode, and the nearer they are to the cathode when they begin the journey the smaller will be the velocity when they reach the cathode. Thus among the ions produced

by the positive rays we should expect that the greater number would have velocities well below the maximum, so that if these only were taken into account the density of the parabolas would be small at the head and would increase towards the part corresponding to smaller velocities.

Let us now consider the retrograde rays. These will not multiply as they move away from the cathode, though their energy will increase somewhat as they approach the negative glow; as, however, they acquire a high velocity even when quite close to the cathode we should expect that the ionization they produce would be fairly uniform throughout the dark space with a tendency to increase in the neighbourhood of the negative glow. The parabolas due to the particles produced by this type of ionization ought therefore to be more uniform in intensity than those due to particles produced by either cathode or positive rays. The ionization due to radiation would, apart from absorption, be uniform throughout the dark spaces and would in this respect resemble that produced by the retrograde rays.

Thus, to sum up, ionization due to cathode rays should produce parabolas with a maximum of intensity at their heads; ionization due to positive rays, parabolas with a maximum some way from the head; while ionization in the dark spaces due to either retrograde rays or radiation ought to give rise to parabolas of fairly uniform intensity. If we confine our attention to the intensities at the heads of the parabolas we eliminate the ionization due to the positive rays, while we can eliminate that due to the cathode rays by studying the intensities at some distance from the heads.

In addition to the positive rays produced in the dark space we have those produced in the negative glow. Since in this region the electric force is exceedingly small the particles will not acquire any appreciable velocity until they emerge from it into the dark space, so that all particles from the

negative glow will reach the cathode with practically the same velocity as those which start from the boundary of the dark space, and will strike the photographic plate close to the head of the parabolas. The positive rays themselves will not, while in the negative glow, acquire sufficient energy to produce ionization, but the cathode rays, the retrograde rays and the radiant energy may well be able to ionize the gas in this region. If the great majority of the positive rays started from the negative glow the intensity at the heads of the parabolas would be very large compared with that of the rest of the arcs. As a matter of fact this is very frequently, though by no means invariably, the case. Thus in the photograph reproduced in Fig. 1, Plate III, the head of the parabola representing the hydrogen molecule is exceedingly faint, while there is a great increase in intensity at the place which would be hit by particles whose kinetic energy was half that due to a fall through the whole potential difference between the anode and cathode. This might be explained by supposing that no charged molecules, but only charged hydrogen atoms, were produced by the discharge, and that the charged molecules which gave rise to the parabolas were formed by one of these charged atoms combining after it had passed through the cathode with an uncharged atom of hydrogen.

The great length of the parabolas shows that the particles which give rise to them, and which are all of the same kind, have a wide range of velocities. One explanation of this range is that the particles originate in different parts of the dark space and so fall through different potential differences and, therefore, reach the cathode with different velocities. That this is one reason for the difference in velocities is supported by the following experiment—

A rod a attached to a glass tube which fitted into a ground-glass joint at b carried a small metal disc, and by rotating

the tube the disc could either be put on one side out of the way of the stream of cathode rays coming from the cathode or else put right in front of that stream and of the opening in the cathode through which the positive rays passed. The pressure was such that the disc was well inside the dark space. Photographs were taken (1) with the disc out of the way (2) with it right in front of the cathode. When these were examined it was found that the intensity of the positive rays with the disc in front was much less than when the obstruction was removed, and again that the heads of the parabolas, when the disc was in front, were further away from the vertical in the proportion of 7 to 5 than when it was away. This shows that the insertion of the disc had reduced the maximum kinetic energy of the rays to $5/7$ of its normal value; this proportion depends on the position of the disc in the dark space; the nearer it is to the cathode the greater the reduction of the maximum energy. No effect is produced unless the disc is in the dark space. The most natural explanation of this experiment is that whereas in the normal case the positive rays are drawn from the region between f the cathode and g the boundary of the dark space, when the disc is inserted at d , the supply from dg is cut off, and that from fd left; as the potential difference between the cathode and d is less than that between the cathode and g the maximum energy of the positive rays is diminished by the insertion of the disc.

There are other reasons which might be suggested for the range in velocities. For example, since all the photographs given in this book were taken when the discharge was produced by an induction coil, and as the potential difference between the terminals of this instrument varies from zero to its maximum value, it might be thought that the particles with the greater velocity were those produced when the potential difference due to the coil had its maximum value

while the lower velocities were produced under the smaller potential differences. If this were the explanation the velocities should become constant if a constant potential difference were maintained between the electrodes, so that if a large electrostatic induction machine were used instead of an induction coil the parabolas ought to be reduced to points. This, however, is not the case.

Another cause which would produce a variation in the velocity of the particles is the passage backwards and forwards between the charged and uncharged state, which we have seen goes on after the particles have passed through the cathode, and which, presumably, also goes on while the particles are passing through the dark space on their way to the cathode. When the particles are without charge they will not be acted upon by the electric force in the dark space and so when they reach the cathode their energy will be less than it would have been if they had been charged for the whole of the time. As the proportion between the time the particle has a charge and the time it has not, will vary from particle to particle, the different particles will reach the cathode with different velocities. Though an effect of this kind must exist, it is not sufficient to explain all the variations of velocity in the particles. It is difficult, for example, to reconcile this explanation with the abrupt way in which the parabolas commence, when the pressure in the discharge tube is low. The head of a parabola is caused by the particles which have acquired the maximum amount of kinetic energy while passing through the dark space; this will depend upon the proportions between the times the particles are charged and uncharged. Suppose that the thickness of the dark space is comparable with the lengths λ_1, λ_2 discussed on p. 48; then there is a finite chance that a charged particle starting from the boundary of the dark space may reach the cathode without losing its charge,

so that some of the particles will acquire the energy due to the full fall of potential. The expectation of a particle passing without loss of charge and having the maximum energy may not be so great as that for it to have been without charge for part of its path when the energy it will have acquired will be less; there will be thus a certain energy, or velocity, of the particles for which the expectation is a maximum and at the point on the parabola corresponding to this velocity the density of the photograph will be a maximum. The density, however, will fall away gradually on either side so that the parabola will not begin abruptly at the velocity for which the expectation is greatest, unless that velocity is the maximum due to the fall through the whole potential difference between anode and cathode. At low pressures, however, the parabolas commence quite abruptly and the variation in intensity does not show any resemblance to that which would be represented by the ordinate of a probability curve.

Wien compared the energy in the particles as calculated from their electrostatic deflection by means of equation (2), p. 21, with the potential difference between the anode and cathode, the latter being calculated by the method of the alternative spark gap. He came to the conclusion that the energy of the particles was only about one-half of that which they would acquire by falling through the potential difference between the anode and cathode. This would be the case if the free path of the particles when charged was equal to that when it was uncharged, and each of them a small fraction of the thickness of the dark space.

I tested the relation between the energy of the particles and the potential fall by a different method, as the method of the alternative spark gap is not under all conditions a very satisfactory way of measuring potential differences. The

method is shown diagrammatically in Fig. 31A. C is the perforated cathode through which the positive rays pass, E the parallel plates which produce their electrostatic deflection, and P the photographic plate by which they are detected. The anode A is also perforated, the perforations of C and A

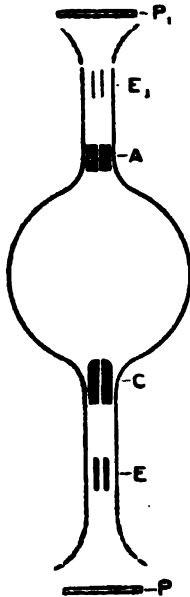


FIG. 31A.

being in the same straight line. The cathode rays from C pass through the perforation in A and then between a pair of parallel plates E_1 , exactly similar in shape, size and distance, apart to those at E. The cathode rays then fall on a plate P_1 covered with powdered willemite and in such a position that P_1E_1 is equal to PE: equal potential differences were applied to the plates E and E_1 and the electrostatic deflection of the cathode rays compared with that of the heads of the parabolas P due to the positive rays. These two deflections were found to be very nearly equal. Since under similar geometrical conditions equality of electrostatic deflection means equality of kinetic energy, the kinetic energy of the cathode rays must be equal to that of the particles which form the head of the parabolas in the positive rays.

Now, since the cathode particles remain charged throughout the whole of their path, and since the more rapidly moving ones start from the cathode, the energy in the cathode particles will be that due to the fall of the atomic charge through the potential difference between the anode and cathode; and as we have seen that the energy of the swiftest positive rays is equal to that of the cathode rays, this energy must be that due to the fall of the atomic charge through the potential difference between the electrodes and

not to half this difference as in Wien's experiments. The difference in the results is probably due to the difference in the pressure in the discharge tube. I worked with large vessels and probably had much lower pressures in the discharge tube than Wien. It may be pointed out that in a case like that of the hydrogen molecule shown in Fig. 1, Plate III., the particles which are most prominent are those whose energy is equal to that due to *half* the potential between the anode and cathode, though those which have twice this energy can easily be detected in the plate. Again, if the conditions are such that the atomic positive rays in the observation vessel are due to the splitting up, after passing through the cathode, of molecules which were charged all the time they were in the discharge tube, the positive rays being molecules before passing through the cathode and atoms afterwards, the maximum kinetic energy would be half that due to the fall through the full potential difference.

Other observers who have worked at comparatively high pressures have observed that the energy of the positive rays is less than that due to the full fall of potential between the electrodes. Thus, for example, Knipp ("Phil. Mag.," 6, 31, p. 438, 1916), who produced his discharge by means of small storage cells so that there could be no ambiguity about the measurement of the potential difference, found a quite marked effect of this kind, and we shall see (p. 148) that the velocity deduced from the Doppler effect of the positive rays is considerably less than that due to the full fall of potential between the electrodes. We conclude, then, that with very low pressures in the discharge tube the charging and discharging of the particles does not play the primary part in producing the wide range of velocities that exist in the positive rays, though at fairly high pressures it may possibly produce an appreciable effect.

Another explanation of the variation in velocity is that it is due to the collisions between the particles in the positive rays and the molecules of the gas through which they are moving. This, however, is open to two serious objections. The first is that these collisions would produce effects of the same general character on all the lines, and we should expect all the lines on a photograph to show a general resemblance in the way the intensity varied along the parabola. We find, however, sometimes on the same plate, lines which are quite short with all the intensity concentrated at the head and others which are long and of equal intensity throughout. The second objection is that, as we have seen, the only collision which a positive ray particle can survive is one that only produces an inappreciable change in the kinetic energy and velocity of the particle, collisions which lead to a finite loss of energy seem always to be accompanied by "absorption" and to be the death of the positive ray.

The explanation of the range of velocities in these particles, which seems to agree best with the results of observation, is that positive rays originate at different places in the dark space as well as in the negative glow and that they acquire a larger or smaller amount of energy according as they start far away from the cathode or near to it. This explanation would not be valid unless there were finite differences of potential between different portions of the dark space. It would not hold, for example, if, as some have thought, all the fall of potential is concentrated close to the cathode. There is direct evidence that as the particles approach the cathode they gain speed, for Strasser (*Ann. der. Phys.*, 31, p. 890, 1910) found that the Doppler effect of the positive rays due to hydrogen in front of the cathode increased as the rays approached the cathode; there was, however, a well-marked increase in the effect after the

rays had passed through the cathode, suggesting that there is at the surface of the cathode a layer in which there is a considerable increase in potential. Direct measurements of the distribution of potential in the dark space have led to conflicting results as to the reality of this spring in potential at the cathode. Aston ("Proc. Roy. Soc.," 84, A. p. 526), who measured the potential distribution in the dark space in front of very large plane cathodes, found that the electric force in the dark space was directly proportional to the distance from the edge of the negative glow, and that there was no appreciable spring of potential at the cathode. On the other hand, Westphal ("Verh. d. Deutsch. Phys. Gesell.," 12, p. 1910) found by two different methods that while there was considerable electric force in the dark space there was at the cathode a sudden spring of potential amounting to from 27 or 70 per cent of the whole cathode fall in potential. It is probable that these differences can be explained to a considerable extent by differences in the pressure of the gas, for the connection between the velocity of the positive particles and the electric field might be expected to undergo considerable variations in the neighbourhood of those pressures at which the dark space is usually studied. At pressures down to a millimetre or less of mercury the velocity of a positive ion at a point P is proportional to the electric force at that point—it does not depend on the previous history of the ion: the place where it originated, the forces it has been subject to before reaching P and so on. When, however, the pressure is very much lower, so that the effects of collision become inappreciable, all this is changed; the velocity of the ion at P is now determined by the condition that its kinetic energy at P is proportional to the difference of potential between P and the place where the ion originated—it can no longer be determined by the value of the electric

field at P, and the differential equations which determine the distribution of potential will be different in the two cases. These equations become almost hopelessly complicated when we take all the different sources of ionization into account and also pay attention to the effect of the velocity of the cathode and positive-ray particles on the amount of ionization they produce.

To illustrate the point we have just been discussing we shall take the simple case when we only take into account ionization, such as that produced by radiation, which is constant throughout the dark space. Let us take the case when the electrodes are parallel plates whose linear dimensions are very large compared with the distance between them, so that all the quantities concerned depend only on one co-ordinate—the distance from one of the electrodes. Let x be the co-ordinate of a point measured along an axis at right angles to the electrodes, m the number of positive particles, all supposed to be of one kind, per unit volume at this point, u the velocity of these particles at this point, q the number of positive or negative particles produced per unit volume at this point in unit time by the source of ionization, then if x is measured in the directions in which the positive particles are moving and we neglect the re-combination of the ions, we have when things are in a steady state

$$\frac{d}{dx}(mu) = q.$$

We have supposed q to be independent of x ; hence

$$mu = qx \dots \dots \dots (I)$$

if x is measured from the boundary of the negative glow where $u=0$. If V is the electric potential at the point x

$$\frac{d^2V}{dx^2} = -4\pi(m-n)e$$

where n is the number of electrons per unit volume. Now,

since the velocity of the electrons is enormously greater than that of the positive particles, unless practically the whole of the current is carried by the negative particles, and we shall return to this point later, n will be small compared with m , and we have approximately

$$\frac{d^2V}{dx^2} = -4\pi me.$$

Let us first suppose that the pressure is high enough to make the velocity of the ion proportional to the electric force, then

$$u = -k \frac{dV}{dx}$$

where k is the mobility of the positive ion; substituting the values for m and u in equation (1) we have

$$k \frac{dV}{dx} \frac{d^2V}{dx^2} = 4\pi eqx$$

or
$$k \left(\frac{dV}{dx}\right)^2 = 4\pi eqx^2$$

since dV/dx vanishes when $x=0$; thus

$$\frac{dV}{dx} = \left(\frac{4\pi eq}{k}\right)^{\frac{1}{2}} x \dots \dots \dots (2)$$

or the electric force is proportional to the distance from the negative glow. This is the result obtained by Aston in the experiments already quoted. Integrating equation (2) we find

$$V = \left(\frac{\pi q}{k}\right)^{\frac{1}{2}} x^2$$

if V is taken as zero at the edge of the negative glow.

Since the velocity of the positive particle at any point is proportional to the electric force at that point, all the particles would have the same velocity at the same point even though they had been produced at different parts of the dark space. To explain the variation in the velocity of the positive particles in the positive rays, we must suppose that the pressure is too low for the particles to acquire a terminal velocity. We shall

suppose that the particles at any point have the velocity which they would acquire in passing freely to this point from the place where they were liberated: u the velocity of a particle at P will be given by the equation

$$\frac{1}{2}Mu^2 = Ve$$

where M is the mass of the particle, e its electrical charge, and V the difference of potential between P and Q the place where the particle was liberated.

Hence
$$u = \left\{ \frac{2Ve}{M} \right\}^{\frac{1}{2}}$$

If q particles were produced per second at Q, then if m is the number of these particles per unit volume when they reach P

$$mu = q,$$

or
$$m = \left\{ \frac{2Ve}{M} \right\}^{\frac{1}{2}} \cdot q$$

Now consider a place P at a distance x from the dark space; particles will be found there which have been produced at all places intermediate between the boundary of the dark space and P. If q_{ξ} be the number produced per unit volume per unit time at a distance ξ from the boundary, V_{ξ} the potential at this place and V_x the potential at P, then the number of positive particles per unit volume at P due to the ionization between P and the boundary will be

$$\frac{1}{\{2e/M\}^{\frac{1}{2}}} \int_0^x \frac{q_{\xi} d\xi}{(V_x - V_{\xi})^{\frac{1}{2}}}$$

while if a stream Q flows from the negative glow across unit area of the boundary per second it will contribute

$$\frac{Q}{\{2e/M\}^{\frac{1}{2}}} V_x^{-\frac{1}{2}}$$

to the density of the positive particles at P. If the number

of positive particles far exceeds the number of negative, then the number of the positive particles at P is equal to

$$\frac{1}{4\pi e} \frac{d^2 V_x}{dx^2}$$

hence we have

$$\frac{1}{(2e/M)^{\frac{1}{2}}} \left\{ \int_0^x \frac{q_{\xi} d\xi}{(V_x - V_{\xi})^{\frac{1}{2}}} + \frac{Q}{V_x^{\frac{1}{2}}} \right\} = \frac{1}{4\pi e} \frac{d^2 V_x}{dx^2} \quad \dots (1)$$

If we assume

$$\begin{aligned} q_{\xi} &= A\xi^m \\ V_{\xi} &= B\xi^n \end{aligned}$$

this equation may be written

$$\frac{P}{x^{\frac{n}{2}-m-1}} + \frac{Q'}{x^{\frac{n}{2}}} = R x^{n-2} \quad \dots (2)$$

where

$$P = \frac{1}{(2e/M)^{\frac{1}{2}}} \frac{A}{B^{\frac{1}{2}}} \int_0^1 \frac{\eta^m d\eta}{(1-\eta^n)^{\frac{1}{2}}}$$

$$Q' = \frac{1}{(2e/M)^{\frac{1}{2}}} \frac{Q}{B^{\frac{1}{2}}}$$

$$R = \frac{1}{4\pi e} B \cdot n(n-1).$$

If Q' is finite we must have

$$\frac{n}{2} - m - 1 = \frac{n}{2} = -(n-2) \quad \dots (3)$$

or $m = -1. \quad n = \frac{4}{3}.$

Thus, in this case, the potential is proportional to $\xi^{\frac{4}{3}}$ where ξ is the distance from the junction of the negative glow and the dark space, the electric force is proportional to $\xi^{\frac{1}{3}}$, and not to ξ as in Mr. Aston's experiments, where, however, the pressure was considerably higher than is usual in experiments with positive rays.

When $m = -1$, the value of P becomes infinite; we may, however, evade this difficulty as follows. If Q'' is the number of ions produced per second in the dark space

$$Q'' = \int_0^d q_{\xi} d\xi = \int_0^d A \frac{d\xi}{\xi}$$

and Q'' is also infinite, we can, however, without difficulty show that

$$P = \frac{1}{(2e/M)^{\frac{1}{2}}} \frac{1}{B^{\frac{1}{2}}} \frac{2}{3} Q''.$$

Substituting in equation (2) we get

$$\frac{1}{(2e/M)^{\frac{1}{2}}} \frac{1}{B^{\frac{1}{2}}} \left\{ \frac{2}{3} Q'' + Q \right\} = \frac{1}{4\pi e} \frac{4. B}{9}$$

or

$$B = \left\{ \frac{9\pi e}{(2e/M)^{\frac{1}{2}}} \left(\frac{2}{3} Q'' + Q \right) \right\}^{\frac{1}{2}}$$

and the potential at a distance $\xi = B\xi^{\frac{1}{2}}$.

Since the ionization is inversely proportional to the distance from the negative glow most of the ions will be produced near the boundary of the dark space and will have the maximum velocity when they reach the cathode. Thus in this case the heads of the parabolas will be much brighter than the tails.

If no particles travel in from the negative glow $Q' = 0$, and instead of the two equations (3) we have the equation

$$\frac{n}{2} - m - 1 = -(n - 2)$$

or

$$n = 2 + \frac{2}{3} m$$

If $m = 0$, $n = 2$, which corresponds to uniform ionization and uniform gradient of electric force in the dark space, and we find

$$V = \left(\frac{\pi^2 e q}{(2e/M)^{\frac{1}{2}}} \right)^{\frac{1}{2}} \xi^{\frac{3}{2}}.$$

This agrees with the distribution of potential found by Aston.

Since the ionization is uniform throughout the dark space the parabolas in this case would be of fairly uniform intensity.

In these calculations the potential difference considered is that from the boundary of the dark space to a point in the

gas ; if there is a jump V_0 in potential at the cathode the cathode fall of potential, i. e. the potential difference between the cathode itself and the boundary of the dark space,

will be
$$V_0 + \left(\frac{\pi^2 e q}{2e/m} \right)^{\frac{1}{2}} d^2$$

where d is the thickness of the dark space.

If the radiation which caused the ionization were excited by the impact of the positive rays against the cathode, since qd is the number of positive particles striking in unit time against the cathode, the energy given to the cathode per unit time is $qdVe$, if V is the cathode fall. If R , the radiant energy is proportional to this energy, then R will equal $kqdVe$, where k is a constant.

But q will be proportional to the amount of R absorbed, hence we may write $q = cR\rho$ where ρ is the density of the gas and c a constant, characteristic of the gas: from this equation we have, substituting the value for R ,

$$q = ckqd\rho Ve,$$

or for the same gas $Vd\rho = \text{constant} \dots \dots \dots (4)$

Thus as long as the current through the gas is below the value at which the potential fall begins to depend on the current, the thickness of the dark space will be inversely proportional to the density of the gas; when, however, the current gets large and the cathode fall of potential increases with the current then the dark space will contract as the current increases. This, as far as it goes, agrees with experience, but as radiation cannot be the only source of ionization we should not expect the relation expressed by (4) to be more than an approximation.

The question whether V_0 is or is not finite will depend upon the conditions governing the transference of the electric charges from the gas to the cathode. Eisenman ("Verh. d. Deutsch. Phys. Gesell.," 14, 6, p. 297, 1912), who has

investigated the distribution of potential in the neighbourhood of the cathode, finds a jump in the potential at the cathode which increases as the pressure diminishes.

We may point out in passing that the ionizing effect of radiation would be to make a self-sustained electric discharge possible even in an absolute vacuum. For, suppose we have two electrodes in such a vacuum and that an electron is in the field, under the electric force it will be driven against the anode and will give rise to radiation; this radiation falling upon the cathode will cause it to give out electrons; these will in turn be driven against the anode and will give rise to radiation which will again eject electrons from the cathode. Thus the discharge will be maintained when the potential difference between the electrodes is great enough to give so much energy to an electron that the radiation it produces when it strikes against the anode is sufficiently intense to liberate one electron from the cathode. Thus a body charged up to more than a certain potential would lose its charge even if placed in an absolute vacuum. It is interesting to notice that in a case like this the speed of the electrons might exceed that due to a fall through the potential difference between the anode and cathode. For when electrons are ejected from a surface by radiation they start with a definite amount of energy, which by Planck's law is proportional to the frequency of the radiation. Now this frequency will depend upon the energy possessed by the electron when it struck against the anode. Thus, suppose an electron were driven against the anode with the energy due to the cathode fall. The radiation it would excite would eject electrons from the cathode, these would start with an amount of energy equal (say) to E . When they struck against the anode they would have an amount of energy equal to E plus that due to the cathode fall; they would have more

energy than the original electron and thus would give rise to radiation of a higher frequency. This radiation would eject electrons from the cathode with initial energy greater than E , thus the radiation due to these would be of a still higher frequency and would give still more initial energy to the particles it ejected. The tuning up of the radiation would go on until the frequency got so great that the number of electrons ejected by a given amount of energy in this form of radiation began to fall off, as there is evidence it does, with increase of frequency after a critical frequency is passed.

In a discharge tube under ordinary conditions the chief source of radiation seems to be the negative glow, little in comparison seems to come from the dark space. What is the origin of this difference, and what is the condition which fixes the limits of the dark space? I think the answer to this question is that in the dark space the electric force is considerable, while in the negative glow it is inappreciable; the boundary of the dark space is fixed by the field of electric force and is the place where this force vanishes. As the positive ions move more slowly than the negative ones there must be an excess of positive electricity around the cathode; this will make the electric force diminish in intensity as the distance from the cathode increases. When the intensity of the force is above a certain value the free electrons are driven away as fast as they are formed, and there are none left to combine with the positively charged ions, so that if the reunion of an electron and an atom is essential for radiation the existence of the electric force will prevent its formation; thus the boundary of the dark space is the surface over which the electric force is zero. Though in the main there is little luminosity in the dark space, yet, as for example, when perforated cathodes are used, bright pencils of light

may be seen reaching right up to the cathode. The luminosity of these, like that of the pencil of positive rays, after it has passed through the cathode is due to the return of an electron to the positively charged particle, this electron not being, however, a free electron, but one taken from the molecules of the gas through which the particles are passing.

We have referred above to the question of the proportion of current carried respectively by the positively electrified particles and the electrons. This subject has recently been investigated by Mr. Aston,¹ who measured the proportion between the quantity of positive electricity passing through a slit in the cathode and the total current passing through the discharge tube. By using slits of various areas he showed that the amount of positive electricity passing through the slit was proportional to the area of the slit. Then on the assumption, perhaps open to question, that the positive electricity passing through the slit was equal in quantity to that which would strike against an equal area of an unperforated electrode, he estimated that in his experiment the positive particles carried fifty per cent of the current. If the positive particles carry anything approaching to this amount the number of positive particles in the dark space must be very large compared with the number of free electrons, so that in the equation

$$\frac{d^2V}{dx^2} = 4\pi (n - m)$$

it is legitimate to neglect, as we have done, n in comparison with m .

To sum up the results of the preceding considerations, the range of velocities in the positive particles is evidence that these are produced to some extent throughout the whole of the dark space. The concentration of particles about

¹ "Proc. Roy. Soc.," 96, p. 200.

different velocities which produces the beading of the parabolas is, however, not due to special foci of production but to the splitting up of molecules and perhaps also to the formation of new systems after the particles have passed through the cathode.

Since the positive particles will not be able to get through the fine tube in the cathode unless they are moving along the axis of the tube, it is only those particles which are formed in the region adjacent to the prolongation of this axis in the discharge tube which can pass through the cathode. Those formed in outlying regions would not be moving in the right direction when they struck the cathode. Thus to get a copious supply of positive rays it is desirable to concentrate the discharge as much as possible along the axis of the tube, and we can understand the great influence which the shape of the front of the cathode has upon the brightness and range of velocities in the positive rays.

THE METHOD OF CONSECUTIVE SYSTEMS OF ELECTRIC AND MAGNETIC FIELDS

A considerable amount of information about the behaviour of the positive particles can be obtained by an extension of the method described on p. 45. This extension consists in having two systems A and B of electric and magnetic fields placed at some distance apart in the path of the positive rays, the displacements due to the magnetic and electrostatic fields are respectively vertical and horizontal. Suppose A is the system nearest the cathode, and that we take a photograph which we shall denote by I. with the electric and magnetic fields at A in action, but those at B out of action, and compare this with another photograph II. taken with A still in action and in addition a magnetic field at B. Let us

consider the effect on a line in I. due to a charged atom. If all the particles producing this line retained their charges while passing from A to B the line would simply be displaced vertically; there would be no resolution of the line; as far as the atomic lines are concerned there would be as many lines in photograph I. as in II. Next, suppose that some of the particles which were charged while passing through A lost their charge before getting to B: these will not be affected by the magnetic field at B, and so photograph II. will show in addition to the displaced line (α) one (β) in the same position as the line in photograph I. Another possibility is that some of the particles should get another charge while passing from A to B. These particles would be more deflected by B than those with one charge and will give rise to a line γ where the vertical displacement is twice that of α . Thus one line in I. might give rise to three lines in II. of which the middle one might be expected to be the strongest. If the original line were due to a doubly charged atom there again might be three lines, one corresponding to the particle retaining its charge, another to its losing one charge and the third to its losing both. In this case the most deflected line might be expected to be the strongest.

Let us now take the case of a line due to a molecule. Here the possibilities are greater than for the atomic line, for in addition to losing its charge the molecule may split up into atoms between A and B. If some of the molecules were to split up into two equal atoms the displacement of these by B would be twice that of the unaltered molecule and corresponding to one line in I., we should have three lines in II. with the spacing and intensity similar to those corresponding to an atomic line. If, however, the molecule were to split up into atoms of different masses, M_1 and M_2 , there would be one line with a displacement $(M_1 + M_2) / M_1$

times the normal displacement δ and another with the displacement $(M_1 + M_2) / M_2$ times the normal.

For example, if H_3 were to split up into H and H_2 then corresponding to the line H_3 on photograph I. there would on II. be one line whose displacement was 3δ and another whose displacement was 1.5δ .

If instead of producing the parabolas by A we produce them by B and take photographs I. and II. with the magnetic field at A off and on respectively, then corresponding to an atomic line in I. we might have two lines in II., one a displaced line due to particles which were charged while passing through A and B and the other an undisplaced line corresponding to particles which were uncharged while passing through A, but acquired a charge before passing through B. If the line were due to a doubly charged atom there might be a third line due to particles which had one charge in A and acquired another charge before reaching B, the displacement of this would be one-half that of the normal line. Next consider a line due to a molecule. We should have two lines, one α corresponding to particles which were charged in both A and B, another undeflected corresponding to particles uncharged in A but charged in B: and if two atoms could combine and form a molecule without suffering appreciable deflection we might have two other lines due to particles which were in the atomic state in A but had united to form a molecule in B. These would be more deflected than the normal line α which might be expected to be much the brightest line of the series. As the behaviour of the lines due to molecules differs from that of a line due to atoms we can use this method to distinguish between the atomic and molecular lines.

Another application I have made of this method is to take a photograph of the parabolas due to B and then apply

to A an electrostatic field strong enough to drive all the particles which were charged while passing through A against the plates so that the only particles which are recorded on the photographic plate are those which were uncharged whilst passing through A but gained a charge before reaching B. These are but a small fraction of the whole number of particles, so that the spectrum is very much less intense. Indeed, with more than two hours' exposure I could only detect the line due to H and H_2 , while the photograph without the electrostatic field had, after an exposure of a few minutes, shown lines corresponding to H, H_2 , C, O.

A striking feature of the photograph with the electrostatic field was the change in the relative intensities of the H and H_2 lines; with the field on H_2 was very much stronger than H, while without the field there was very little difference.

Though cathode rays may produce some charged atoms they more frequently produce charged molecules, the chief source of the charged atoms being positive rays, i. e. rapidly moving charged molecules or atoms. The view that the charged atoms and molecules are produced by different agents helps us to understand the remarkable variations which occur in the relative intensities of the lines due to the atoms and molecules of the same element to which we have already referred.

METHODS FOR MEASURING THE NUMBER OF THE POSITIVELY ELECTRIFIED PARTICLES

Though the photographic plate furnishes an excellent means of detecting the existence of positively charged particles of different kinds it is not suitable for comparing the number of these particles present in a bundle of positive rays. For though the intensity of the lines on the photograph will vary

with the number of particles, this number will not be the only factor in the expression for the intensity. As an example, consider the lines due (1) to the very light particles like the atoms of hydrogen, and (2) to very heavy ones like the atoms of mercury. If these particles have acquired the same amount of energy in the electric field before entering the cathode, the hydrogen atoms will have a velocity about fourteen times that of the mercury ones: they might therefore be expected to penetrate further into the film on the plate and produce a greater photographic effect than the mercury ones. If this expectation is realized, and we shall see that it is, it is evident that the photographic effect cannot be taken as a measure of the number of positively electrified particles.

A method which does give metrical results is founded on the following principle. Suppose that we replace the photographic plate in the preceding method by a metal plate in which there is a movable parabolic slit, then when this slit is moved into such a position that it coincides with one of the parabolas on the photographic plate, positively electrified particles will pass through the slit; if these particles are caught and their total charge measured we shall have a measure of the number of positively electrified particles of this kind. Thus if the slit were gradually moved up the plate there would be no charge coming through it, unless it coincided in position with one of the parabolas. As one parabola after another was passed, positive electricity would come abruptly through the slit, and the amount of the charge would be a measure of the number of particles passing through the slit. If instead of moving the parabolic slit we keep the slit fixed and gradually increase the magnetic field used to deflect the particles, we shall in this way drive one parabola after another on to the slit, beginning with the parabola due to the hydrogen atom and ending with that due to the mercury one

and the charges passing the slits will be proportional to the number of particles.

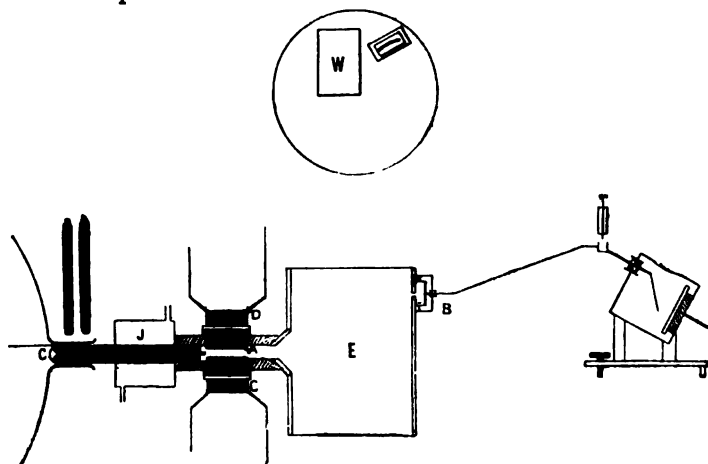


FIG. 32.

The apparatus used to carry this idea into practice is represented in Fig. 32. After passing through the electric and magnetic fields the particles, instead of falling on a photographic plate, fall on the end of a closed cylindrical metal box E. In the end of this box a parabolic slit about 1 mm. in width is cut, the vertex of the parabola being the point where the undeflected rays would strike the box, and the tangent at the vertex the line along which the particles would be deflected by the magnetic force alone. This slit is the only entry into a metal box B. Inside B and immediately behind the slit there is an insulated long, narrow metal vessel placed so that every particle passing through the slit falls into this vessel. This vessel is connected with a Wilson tilted electroscope by which the charge it receives can be measured.

From the face of the box E a portion was cut away, and the opening closed by a willemite screen W. The positive

rays could be deflected on to this screen and the brightness of the fluorescence observed ; in this way one can make sure that the tube is in the proper state for giving positive rays before attempting to make the measurements.

The impact on the face of the box of the rays which do not pass through the slit gives rise to the emission of slowly moving cathode rays ; if precautions are not taken these diffuse through the slit, enter the Faraday cylinder, and confuse the measurements. This diffusion can be avoided by placing a small permanent magnet near the slit. The force due to this is strong enough to deflect the more mobile cathode rays without producing any appreciable effect on the positively charged atoms. The pressure of the gas between this box and the cathode should be made as small as possible : the best way of reducing the pressure is to absorb the gas by means of charcoal cooled with liquid air. This method will not produce a good vacuum when the gas in the tube is helium ; with hydrogen, too, the vacuum is not so good as for heavier gases, for them the pressure can by this means easily be reduced to $3/1000$ of a millimetre of mercury.

The method of observing with this apparatus is as follows : The positive rays are deflected by a constant electric field of such a magnitude that the heads of the parabolas are in line with one end of the slit. The magnetic field is then increased by small increments and the deflection of the Wilson electro-scope in ten seconds measured. Unless a parabola comes on the slit there is practically no deflection ; as soon, however, as the magnetic force is such that a parabola comes on the slit, there is a considerable deflection which disappears when the magnetic force is increased so as to drive the parabola past the slit. The appearance and disappearance of the deflection of the electro-scope are surprisingly sharp, so that lines quite near each other can be detected and separated.

An example of the results obtained by this method is given in Fig. 33. The abscissæ are the values of the magnetic force used to deflect the rays, and the ordinates the deflection of the Wilson electroscopè in ten seconds. The gas in the tube was carbon monoxide.

A comparison of this curve with a photograph of the discharge through the same gas shows many interesting features. On the photograph the strongest lines are those corresponding

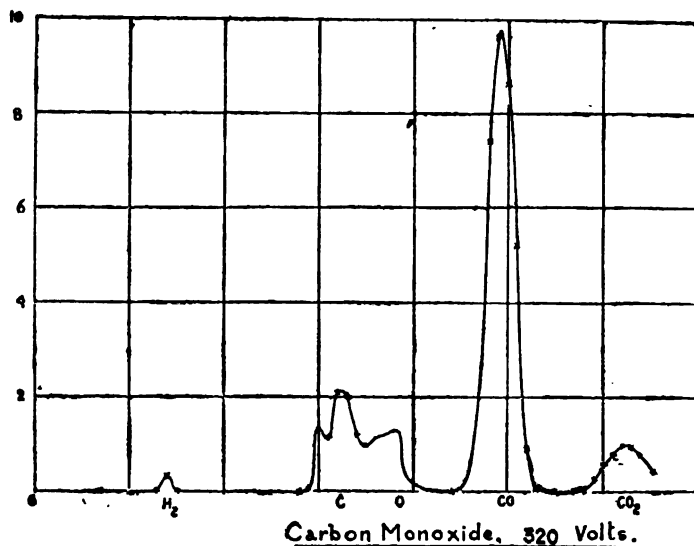


FIG. 33.

to the atom and molecules of hydrogen. The curve on the other hand shows that the number of hydrogen particles is only a small fraction of the number of CO particles. The extraordinary sensitiveness of the photographic plate for the hydrogen atom in comparison with that for atoms and molecules of other gases is shown in all the curves taken by this method. But great as is the discrepancy in the case of the photographic plate between the effects produced by hydrogen atoms and an equal number of heavier atoms, it is not nearly

so great as it is for a willemite screen: such a screen may show the hydrogen lines very brightly while the CO line is hardly visible, when measurements made with the electroscope in the way just described show that the number of particles of hydrogen is only a few per cent. of the number of the CO particles.

It is difficult to get from the photographs any estimate of the relative amount of the different gases in the discharge tube when it contains a mixture of several gases; for example, if the tube is filled with a mixture of hydrogen and oxygen the relative quantities of these gases may be varied within wide limits without producing any very marked effect on the relative brightness of the hydrogen and oxygen lines in the photograph. This electroscope method is much more metrical, as will be seen from Figs. 34 and 35, the first of which represents the curve when the gas in the tube was a mixture of one-third hydrogen and two-thirds oxygen, while in the second the gas was one-third oxygen and two-thirds hydrogen.

The negatively charged hydrogen atoms seem to have the same preponderance in their effect on the photographic plate over other negative atoms as positive hydrogen atoms have over other positive atoms. Thus on all the plates the line corresponding to the negatively electrified hydrogen atoms is well marked, often being comparable with the negatively electrified oxygen atom. With the electroscopic method the negative hydrogen atom can only just be detected, while the negatively electrified oxygen atoms produce a large negative deflection. A curve showing the comparative numbers of different kinds of negatively electrified atoms is shown in the curve, Fig. 36: the gas in the tube was phosgene, COCl_2 ; the curve at the top of the figure represents the number of negatively electrified particles, the one at the bottom the positively

electrified ones. It will be seen that the negative atoms de-

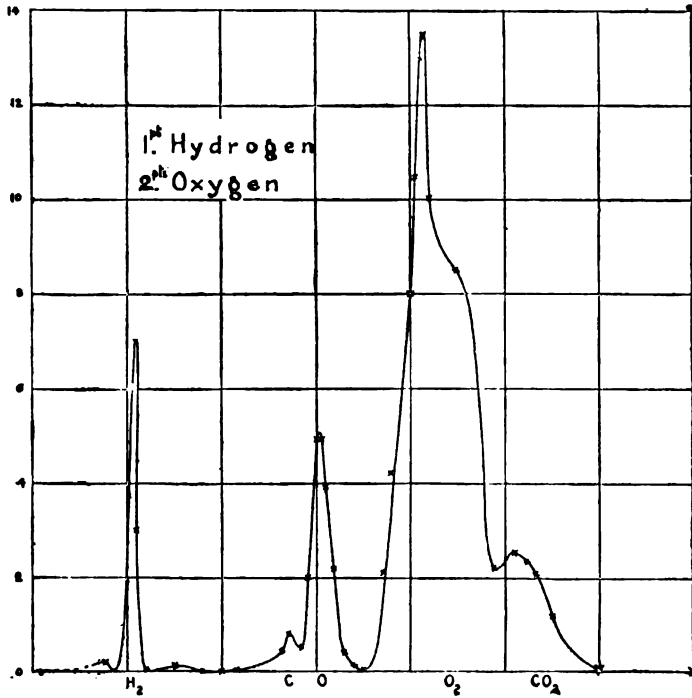


FIG. 34.

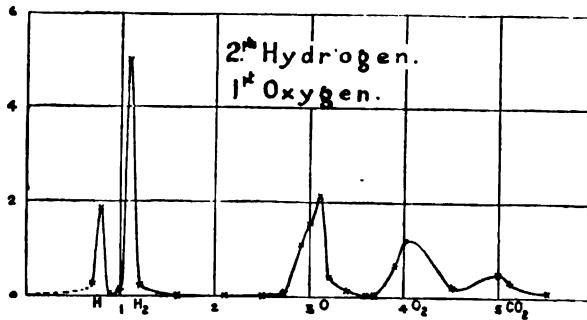


FIG. 35.

tected by the electroscopic method were carbon, oxygen, and chlorine, and that the chlorine atoms were by far the most

numerous. On the photographs taken with this gas the line due to negatively electrified hydrogen seemed comparable in intensity with that due to negative chlorine. An interesting point about the curve representing the distribution of positively

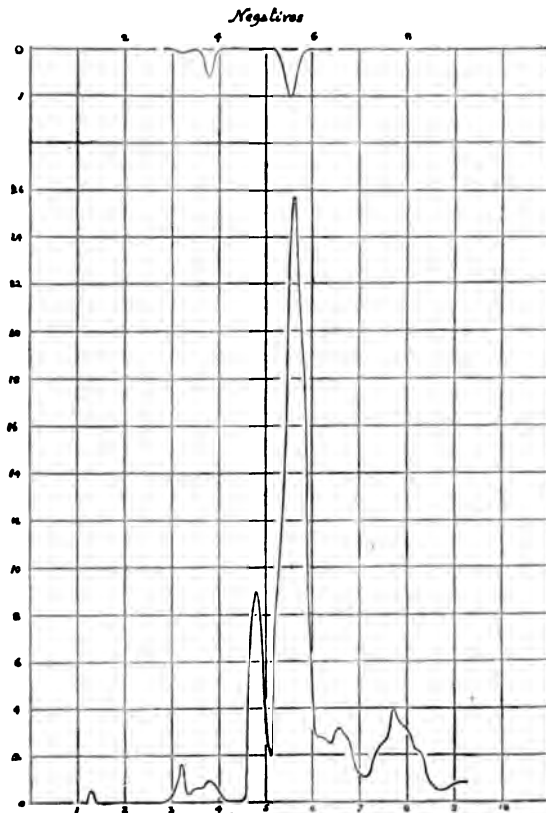


FIG. 36.

electrified atoms is the great variety of atoms and molecules present in the rays; thus we find atoms of carbon, oxygen, and chlorine, and the molecules CO , Cl_2 , CCl , and COCl_2 . It will be noticed that only a small fraction of the current is carried by free carbon and oxygen atoms, showing that in phosgene

the carbon and oxygen atoms are so firmly united that the greater part of them remain together even when the gas is dissociated.

Are the atoms from a molecule of a compound gas charged with electricity of opposite signs?

The study of the curves obtained by the electroscopic method throws some light on the electrical states of the two atoms in a diatomic molecule of an elementary or compound gas. If we regard the forces which keep the atoms together as electrical in their origin, the question naturally arises, are the two atoms in a molecule of hydrogen, for example, charged one with positive the other with negative electricity; or in a molecule of hydrochloric acid gas is the hydrogen atom positively charged, the chlorine negatively, and if so do the atoms retain their charges when the molecule is dissociated?

Let us consider the case of CO for which we have in Fig. 33 the curve which represents the relative numbers of the different kinds of positively charged atoms. If the carbon atom in the molecule were positively, the oxygen atom negatively electrified, then we should expect that if a molecule of CO were split into atoms by the impact of a rapidly moving positively electrified particle, there would be a tendency for the carbon atoms to have a positive charge and for the oxygen ones to have a negative, so that in the positive rays we should expect to find more carbon atoms than oxygen ones. The curve, Fig. 33, shows that the number of positively electrified carbon atoms exceeds that of the positively charged oxygen ones in the proportion of 11 to 7. These figures, however, underrate the number of oxygen atoms which came through the cathode, for some of them after passing through the cathode acquired a negative charge. The charges given to the electroscope show that the proportion between negatively and positively charged oxygen atoms was as 2 to 7, while the

number of carbon atoms which were negatively charged was very small in comparison with that of the positively charged atoms. Taking the negative atoms into account as well as the positive we find that the proportion between the number of carbon and oxygen atoms passing through the cathode is as 11 to 9; the numbers are too nearly equal to allow us to suppose that after dissociation one of the atoms is positively, the other negatively charged.

The curve for COCl_2 , Fig. 36, shows that the proportion of positively electrified chlorine atoms in the positive rays to the positive CO particles is not very different from the proportion between the atoms of chlorine and CO to the normal gas. If the atoms in the molecule COCl_2 had after dissociation carried electric charges we should have expected the atoms of the strongly electro-negative element chlorine to have carried a negative charge and to have been relatively deficient in the positive rays.

The view that each of the atoms derived from a molecule of a compound contains as much positive as negative electricity is supported by considerations drawn from other branches of physics. If the atoms in a molecule of a gas carried separate charges so that one kind of atom was positively, another negatively, charged, then if the gas were dissociated into these atoms and if the atoms retained their charges the dissociated gas would be a good conductor of electricity. Now there are several gases which are dissociated at low temperatures: nickel carbonyl, for example, is at 100°C . split up into nickel and CO to a very large extent; if these atoms were charged the electrical conductivity of the gas might be expected to begin to show marked increase at a temperature of about 70°C . when the dissociation first becomes appreciable. The variation of the conductivity of nickel carbonyl with temperature is, however, as Prof. Smith has shown, quite normal, following

the same laws as for an undissociated gas. L. Bloch,¹ too, has shown that the dissociation of arseniuretted hydrogen which also takes place at low temperatures is not accompanied by any increase in electrical conductivity. He also showed that many chemical reactions between gases which go on at low temperatures such as the oxidation of nitric oxide, the action of chlorine on arsenic, the oxidation of ether vapour, have little or no effect on the conductivity.

Chemical action between gases, unless accompanied by high temperature, has not been shown conclusively to give conductivity. The very vigorous combination of hydrogen and chlorine under sunlight seems to have absolutely no effect on the electrical conductivity of the mixture, and this is a strong reason for supposing that the atoms in the molecules H_2 and Cl_2 are not charged.

It is true that chemical action vigorous enough to raise the gases to a very high temperature, such as, for example, the combination of hydrogen and oxygen in the oxy-hydrogen flame, the oxidation in a Bunsen flame, the burning of CO and so on, make the reacting gases good conductors of electricity. This conductivity seems, however, from the result of recent experiments, to be due to the high temperatures produced by the chemical action rather than to that action itself. The conductivity cannot be due to the molecule being dissociated into positively and negatively electrified atoms, for the determinations of the mobility of the negatively electrified particles in flames and gases at a very high temperature show that it is much larger than would be possible if these particles had masses comparable with that of even the lightest atom.

In considering the ionization of flames we have to separate two effects—

¹ "Annales de Chimie et de Physique," [8] XXII, pp. 370, 441; XXIII, p. 28.

(a) An effect due to the contact of the flame with hot bodies. We know that many solids give out electrons when heated to a high temperature: the oxides of calcium and barium do this to quite an exceptional extent. Thus when the flame is in contact with solids, as it is when electrodes are introduced into the flame or when solid particles are scattered through it, these being raised to incandescence will emit electrons which will be scattered through the gas.

(b) We have next to consider the effect produced by the high temperature of the gas itself apart from the effects produced by solids. At a temperature of 2500° C. the average kinetic energy of a molecule due to thermal agitation corresponds to that represented by the fall of the atomic charge through a potential difference of about one-third of a volt. To ionize a molecule of a gas by electrons requires the expenditure of an amount of energy which varies from gas to gas, but which is of the order of 10 volts; this kind of ionization gives rise to free electrons. For ionization of this type an atom or molecule is very inefficient compared with an electron, and we should, from the considerations given on page 57, expect that to liberate a free electron an atom of hydrogen would require an amount of energy represented by some 10,000 volts. The number of molecules which even at a temperature of 2500° C. possess this energy would, if Maxwell's law were to hold, not be more than one in $8^{-8} \times 10^6$. We can, therefore, leave out of consideration this type of ionization when considering the effect of collisions. There is, however, another type of ionization which is much more probable, when the colliding atom instead of setting the electron free unites with it and drags it away, thus producing a negatively charged ion instead of a free electron. This method of ionization enables the atom to utilize its energy to better advantage than when it has to

eject an electron by impact. Let us suppose that, under favourable circumstances, it can effect this ionization when its energy is that represented by the ionizing potential, say, 10 volts. The number of molecules which at the temperature of 2500° C. possess not less than this amount of energy

is approximately $\frac{2}{\sqrt{\pi}} \int_{\frac{2}{3} \times 10}^{\infty} e^{-x^2} dx$ or about 8×10^{-10} times

the whole number of molecules. If the gas were hydrogen the number of collisions in a cubic centimetre per second between these high-speed molecules and the other molecules would be about 6×10^9 . Thus, if every one of the collisions with the high-speed molecules resulted in ionization, 6×10^9 ions would be produced per second per c.c. of gas. This ionization, though considerable, would not be anything like sufficient to carry the currents that actually pass through flames.

We conclude that when a molecule is dissociated into atoms these are uncharged. This might have been expected, as it requires in general much less energy to dissociate into uncharged than into charged atoms. Before dissociation, however, it may be that one of the atoms had one kind of charge, the other the opposite. There must, however, be a type of molecule including elementary molecules such as H_2 , where there is no such distinction between the atoms. I have, however ("Phil. Mag.," XXVII, p. 757, 1914), given reasons for thinking that this is not the only type of compound, there is another type of which water vapour is a very conspicuous example, where there is such a separation of electricity inside the molecule that one atom may be regarded as positively, the other as negatively, electrified. Perhaps the most direct argument in favour of this view comes from the study of the specific inductive

capacities of gases. The measurements made by Bædeker ("Zeits. Physik. Chemie," XXXVI, p. 305) show that if K is the specific inductive capacity of a gas, $K-1$ for some gases such as H_2O , NH_3 , and the vapours of the various alcohols, is far in excess of its value for other gases, and, moreover, that the variations of $K-1$ with temperature is quite different for the two types of gases. In the type represented by water-vapour $K-1$ varies rapidly with the temperature, while in the other type if the density of the gas is kept constant there is hardly any variation at all with the temperature. A high value of K and a rapid variation with temperature would follow if the molecule possessed a finite electrical moment, such as it would have if one of its atoms were positively, the other negatively, electrified. The substances belonging to this type possess very energetic properties in the liquid state, they ionize salts dissolved in them, they show the phenomenon of association, the molecules tending to cling together; as the electrical moment gives rise to a very large stray field, these effects, which would result if the molecules exerted appreciable action on each other, might have been anticipated.

From the point of view of the positive rays, the presence of gases of this type in the discharge tube might be expected to produce an increase in the negatively electrified constituents of the rays, since the atoms of the electronegative elements would, after passing through the cathode, be able to obtain a negative charge from the molecule of which they formed a part, and would not have to rely exclusively on obtaining this charge from the molecules of the gas through which they were passing. The negative particles obtained in this way would not possess the kinetic energy due to the full fall of potential between the anode and cathode. Thus, if there were water-vapour in the tube the energy in those negatively charged

oxygen atoms which owed their charge to the decomposition of a molecule of water would only be $\frac{1}{8}$ of the maximum energy ; while if the negatively electrified oxygen atoms owed their charge to the decomposition of the molecule of some alcohol of high molecular weight their energy would be a much smaller fraction of the maximum energy. The production of negatively electrified atoms by the decomposition of molecules would thus not affect the intensity of the heads of the parabolas corresponding to these atoms, they would produce an abrupt increase in intensity at points on the parabolic arc at a distance from the head depending on the type of compound from which the atom was liberated. Some observers—for example, Wien, Dechend, and Hammer—have observed that the negative oxygen was more pronounced when water-vapour was admitted to the tube than when pains were taken to exclude it, and the suggestion has been made that the negative constituents are due entirely to this source. I do not think this position is tenable, as I have found the negative oxygen exceedingly strong after very elaborate precautions had been taken to exclude water-vapour, and, moreover, the decomposition of water-vapour cannot account for the presence of negatively charged hydrogen atoms, one of the most prevalent constituents of the stream of particles which form the positive rays.

RETROGRADE AND ANODE RAYS

The rays we have hitherto been considering consist of positively charged particles travelling in the direction in which such particles would be moved by the electric field in the discharge tube. In addition to these there is another system of rays travelling in the opposite direction. By far the larger portion of these rays are cathode rays, i.e. streams of

electrons moving with great velocity, but, as the author showed long ago,¹ these are mixed with rays which are evidently of a different character, for, unlike the cathode rays, they are not appreciably deflected when a permanent magnet is brought near them. It was afterwards shown by Villard² and the author³ that some of these new rays were deflected by strong electric and magnetic fields and that the direction of the deflection indicated that the particles forming the rays were charged with positive electricity. The fact that these rays travel with high velocities away from the cathode and thus in the opposite direction to the electric forces acting

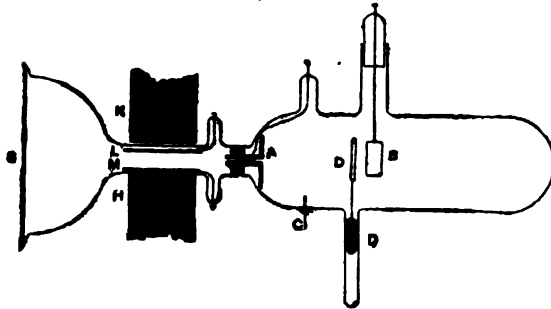


FIG. 37.

upon them makes their investigation a matter of very considerable interest. The apparatus I have used for this purpose is represented in Fig. 37.

A is a perforated electrode through which the rays pass on their way to the willemite screen or photographic plate S. On their journey to S the rays traverse the usual electric and magnetic fields. B is a plane rectangular electrode at the other end of the discharge tube: it is carried by a stopper working in a ground-glass joint and thus can be rotated about a vertical axis. C is a wire fused in the side of the tube for

¹ J. J. Thomson, "Proc. Camb. Phil. Soc.," IX, p. 243.
² "Comptes Rendus," CXLIII, p. 673, 1906.
³ J. J. Thomson, "Phil. Mag.," XIV, p. 359, 1907.

use as an auxiliary electrode. D is a side tube in which a closed glass vessel containing a piece of iron can slide up or down: this vessel carries a piece of fine metal rod which, by moving the iron by means of a magnet, can be inserted in or withdrawn from the line of fire of particles projected from B.

When the stopper carrying the electrode B is turned so that the normal of the plane of the electrode either coincides with the axis of the hole through A, or makes but a small angle with it, then if B is made cathode and a discharge sent through the tube, the cathode rays pass down through the tube in A and produce vivid phosphorescence on the screen. In addition to these rays there are others which produce a phosphorescence different in colour from that due to the cathode rays and are deflected in the opposite direction by the electric and the magnetic fields: the amount of electrostatic deflection is about the same as that for the cathode rays but the magnetic deflection is very much less. It can easily be shown that these are not ordinary positive rays due to A becoming cathode through accidental reversals of the coil. For in the first place they disappear when the electrode B is twisted round so that a normal to its plane no longer nearly passes down the tube through A: and secondly the rays persist when A is disconnected from the induction coil and the auxiliary electrode C used as the anode. Again when the rod attached to D is put in the line of fire a shadow is thrown on the phosphorescence on the screen due to these rays. These rays are strongest when the electrode B is placed so as to be at right angles to the axis of the tube through A. If the electrode is rotated they diminish rapidly in intensity but can be detected until the normal to B make an angle of about 15° with the axis of the tube through A; they appear in fact to follow much the same path as the cathode rays from B, for

much the same rotation was required to prevent the cathode rays getting through the tube in A and producing phosphorescence on the screen.

These rays get exceedingly feeble when the pressure of the gas in the discharge tube is very low and they are no longer observable at pressures when the ordinary positive rays give quite vigorous effects; even when most fully developed they are feeble in comparison with the ordinary positive rays, so that it is necessary for the tube through A to have a much wider bore than is required for experiments with positive rays. As these rays travel in the opposite direction to the positive rays they are called retro-grade rays.

Using a tube through A about .5 mm. in diameter I obtained a photograph of the retrograde rays which gave the following results:—

There are in the retrograde rays positively electrified atoms and molecules of hydrogen and positively electrified atoms of oxygen: there are also negatively electrified atoms of hydrogen and oxygen, and with these rays the intensity of the lines corresponding to the negatively electrified particles is greater than that of the positively electrified ones; with the ordinary positive rays the positive lines are much stronger than the negative. In the retrograde as well as in the positive rays there are large numbers of uncharged particles. The photograph taken with the retrograde rays shows that the maximum velocity of the negatively electrified atom is about the same as that of the corresponding positively electrified one and differs but little from the velocity of these atoms in the ordinary positive rays. This result is suggestive because the electric field in the tube would accelerate the negatively electrified retrograde rays and retard the positively electrified one. It points, I think, to the conclusion that the origin of the retrograde rays is analogous to that of the negatively electrified

particles which accompany the positive rays, the difference between them being that the retrograde rays acquire their negative charge before passing through the cathode, while the negative constituent of the positive rays do so after passing through the cathode. We may suppose that the process by which the retrograde rays are produced is somewhat as follows : neutral atoms or molecules acquire a negative charge when they are just in front of the cathode, they are then repelled from the cathode and driven through the dark space, acquiring under the electric field in the discharge tube a velocity of the same order as that acquired by the positively electrified particles of the positive rays during their approach to the cathode. Some of these rapidly moving negatively electrified particles will in their course through the gas come into collision with the electrons and molecules in the discharge tube ; one collision will detach an electron leaving the particle in the neutral condition ; a subsequent one will detach another electron and leave the particle positively charged. The particles which have made two collisions form the positively electrified portion of the retrograde rays, those which have made one collision the portion which is without charge, and those which have not made a collision the negatively electrified portion of these rays.

These retrograde rays are very well developed when a double cathode of the kind introduced by Goldstein (see p. 5) is used instead of a flat cathode. If a cathode consisting of two parallel triangular plates, Fig. 38, is substituted for the flat cathode B in the apparatus shown in Fig. 37, a plentiful supply of retrograde rays come from the cathode when it is turned into a suitable position. By twisting the triangle round by means of the glass stopper the emission of the rays, both cathodic and retrograde, can be determined. In this way it was shown that the maximum emission of cathodic rays is

along the line starting from the middle points of the sides. At the higher pressures this is practically the only direction in which cathode rays can be detected ; at very low pressures, however, cathode rays can be detected coming from the corners of the triangle as well as from the middle points of the sides. Few, if any, however, are given out in any intermediate direction. The positively electrified particles stream off at all pressures from both the corners and middle points of the sides, but not from the intermediate positions. The most abundant stream comes, as for the cathode rays, from the middle points of the sides, but the disproportion between the streams from the

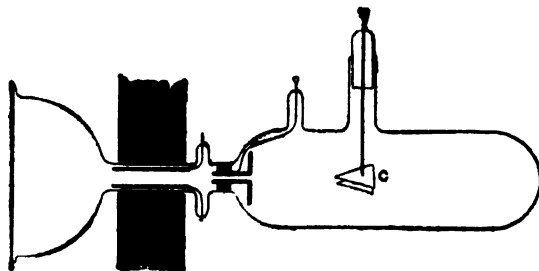


FIG. 38.

corners and from the middle points of the sides is nothing like so large as for the cathode rays, so that the ratio of positive to cathode rays is much the greatest at the corners of the triangle.

A simple method of demonstrating the existence of retrograde rays, and also of the places at which the positive rays originate, is that already described (see p. 15), founded on the difference between the phosphorescence of lithium chloride under cathode and positive rays. When lithium chloride is struck by cathode rays, the phosphorescence is a steely blue giving a continuous spectrum. When struck by rapidly moving positively electrified particles the phosphorescence is a rich deep red, and the red lithium line is very bright in

the spectrum. To explore the tube for positive rays a thin rectangular strip of mica or metal is covered with fused lithium chloride, the strip is attached to a piece of iron¹ which rests on the bottom of the discharge tube. By moving the iron by means of a magnet the strip can be moved towards the cathode or away from it. If we start with the mica strip close to the cathode we find that there is no red light to be seen on the side of the lithium chloride next the cathode. The anode side of the chloride is a brilliant red, showing that the strip is being struck by the positive rays before they reach the cathode but not by the retrograde ones. If the mica strip is pulled farther away from the cathode until the distance between them is about half the thickness of the dark space, red light appears upon both sides of the strip, showing that now it is struck by the retrograde as well as by the positive rays. This state of things continues until the mica reaches the limit of the dark space and approaches the negative glow; in this position the cathode side of the strip is red but the other side is dark, showing that now it is struck only by the retrograde rays. Another way of making this experiment is to keep the strip fixed at a distance of about one or two centimetres from the cathode. Beginning with a fairly high pressure so that the strip is outside the dark space, we find that the cathode side of the strip is red, while the other side is dark; in this position the strip is struck only by the retrograde rays. If the pressure is gradually reduced so that the dark space increases until it reaches just past the mica, both sides of the strips will now show the red light, showing that now positive as well as retrograde rays strike the strip. When the pressure is further reduced until the dark space is three or four centimetres long, the red light disappears from the cathode side but is very bright on the other.

¹ It is better to put the iron in a closed tube and attach the mica strip to the tube, otherwise so much gas is given out by the iron that it is difficult to reduce the pressure sufficiently.

The reason that the retrograde rays are not observed when the screen is close to the cathode is due I think to the shadow cast by the mica on the cathode. The mica stops the positive rays on their way to the cathode so that the parts in shadow are not struck by these rays and so cannot be the origin of retrograde rays, if these are produced in the way we have described.

This view is confirmed by the following experiments. If the cathode is placed near the middle of a large bulb and the mica screen is put a little on one side of the cathode, the red lithium light can be observed on the side of the screen turned towards the cathode even when the screen is quite close to the cathode and the dark space 5 or 6 cm. long.

Again if the cathode stretches across a tube of uniform bore, and the screen is moved towards the cathode, the shadow thrown on the cathode becomes much more marked and suddenly increases in size at the place where the red light fades away from the cathode side of the mica strip. The increase in size is due, I think, to the screen getting positively electrified when in the region close to the cathode. We know by the distribution of electric force in the dark space that there is a dense accumulation of positive electricity just in front of the cathode, which naturally would charge up an insulator placed within it. The positively electrified screen repels the positively electrified particles which pass it on their way to the cathode and deflects them from their course, so that they strike the cathode beyond the projection on it of the screen. In this way a considerably increased area is screened from the impact of the positively electrified particles. The portion so screened no longer emits cathode rays. Thus the region in front of it is traversed by little if any current and there is consequently no bombardment of the screen by retrograde rays.

Somewhat similar effects are obtained if the mica screen

is replaced by a very fine platinum wire. If this wire is slowly moved towards the cathode, starting from a place inside the negative glow, the following effects are observed: almost immediately after entering the dark space the wire becomes red hot and remains so until it reaches the velvety glow immediately in front of the cathode (known as Goldstein's first layer). Here it becomes cold and the shadow which before could hardly be detected now becomes well marked and much thicker than the wire. The change takes place very abruptly. In some cases just before entering this layer the shadow is reversed, i.e. the projection of the wire on the cathode is now brighter than the rest of the cathode, indicating, I think, that the wire when in this position gets negatively electrified and attracts the positively electrified particles instead of repelling them.

The retrograde rays are well developed with cathodes made of wire gauze.

Mr. Orrin H. Smith ("Phys. Review," 7, p. 625, 1916) has investigated the retrograde rays by a somewhat different method. The only types of retrograde rays he could detect were *molecules* of hydrogen and oxygen: these occurred with positive and also with negative charges.

ANODE RAYS

The positively charged particles, which we have hitherto considered, originate in the neighbourhood of the cathode. Gehrcke and Reichenheim¹ have discovered rays of positively charged particles which start from the anode. Their attention was called to these rays by noticing that a pencil of yellow light streamed from a point on the anode of a tube with which

¹ "Verh. d. Phys. Gesell.," 8, p. 559; 9, pp. 76, 200, 376; 10, p. 217.

they were working. It was found that there had been a speck of sodium chloride at the points on the anode from which the pencil started. They got these rays developed to a much greater extent when they used for the anode a piece of platinum foil with a little pocket in which various salts could be placed, and which was heated to redness by a battery insulated from the one used to send the current through the discharge tube. The current through the tube was produced by a battery

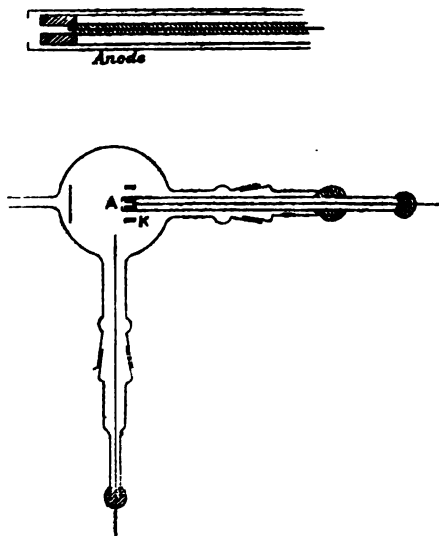


FIG. 39.

giving a potential difference of about 300 volts which, as a Wehnelt cathode was used, was sufficient to send a very considerable current through the tube: the pressure in the tube was very low. The rays were well developed in this tube when NaCl, LiCl, KCl and the chlorides of Cu, Sr, Ba, In, were placed in the pocket. The colour of the rays corresponded with the colour given to flames by the salt. They did not get any effects when the oxides of calcium or barium were put in the

pocket ; these oxides are known when hot to give out large streams of electrons, and for this reason are used for Wehnelt cathodes. These rays are apparently only given out by the salts of the metals and not by the metals themselves ; they are called Anode Rays.

Gehrcke and Reichenheim arranged a Faraday cylinder so that the rays could fall into it ; they found that when the rays entered the cylinder it acquired a strong positive charge.

They subsequently used another form of apparatus which gave better results than the one just described. The anode was a rod of salt placed inside a glass tube so that only the front of it was exposed to the discharge tube ; the cathode was an aluminium ring encircling the anode, the



FIG. 40.

pressure was reduced to a very small value by the use of carbon cooled by liquid air. With the discharge from a powerful induction coil, or still better from a large electrostatic induction machine, the anode got hot without the aid of an auxiliary heating current, and a bright stream of rays came from the end of the salt anode ; the appearance of this beam is represented in Fig. 40. It was found that a mixture of two or more salts with powdered graphite gave brighter rays than a simple salt, the best mixture seemed to be LiBr , LiI , NaI and graphite. The rays come off at right angles to the surface of the salt ; thus if the surface is cut off, as in Fig. 41, the rays come off in the direction AB .

Gehrcke and Reichenheim found that there was a very considerable difference of potential between the surface of the

anode and a point a centimetre or two away: in some of their experiments it was as much as 2300 volts. By assuming that the energy acquired by the rays was due to the fall through this potential V , and measuring the radius of the circle into which the rays were bent by a strong magnetic field H , the values of v and m/e can be determined, for we have

$$\frac{1}{2}mv^2 = Ve,$$

and if r is the radius of the circle into which the rays are bent by a magnetic force H at right angles to the path

$$\frac{mv^2}{r} = Hev;$$

$$\text{hence } v = \frac{2V}{Hr} \text{ and } e/m = \frac{2V}{H^2r^2}.$$

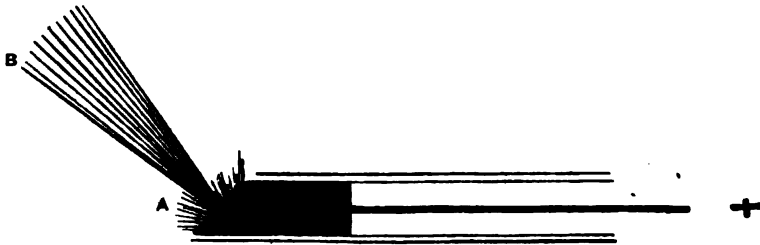


FIG. 41.

In this way the following values were obtained:—

Salt.	v . cm./sec.	e/m .	Ratio of mass of particles to that of an atom of hydrogen
Li Cl.	2.40 2.71×10^7	1.11 1.15×10^8	8.6 — 8.3
Li Cl.	1.89 2.46×10^7	$.69$ $.87 \times 10^8$	14 — 11
Na Cl.	1.87 1.76×10^7	$.46$ $.41 \times 10^8$	21 — 23
Sr Cl ₂ .	1.08×10^7	$.21 \times 10^8$	90 (if the atom is doubly charged).

The results for Li Cl given in the first line relate to the brightest part of the rays, those in the second to the least deflected rays. It would appear from this that the charged particles are the atoms of the metal in the salt, and that in the case of strontium they carry a double charge. A very interesting case of these anode rays is that of a discharge tube with a constriction in the middle. When two bulbs A and B, about 10 cm. in diameter, with the anode in A and the cathode in B, are connected by a narrow tube: then when the pressure in the tube is very low and a *small quantity of iodine vapour* is introduced into it, anode rays start from the constriction *c* at the cathode end of the narrow tube and cathode rays from *d*, the anode end of this tube. These have been observed when the gas in the tube was hydrogen, oxygen, or helium, but not when it was nitrogen. If the connecting tube were quite straight these anode rays might be the positive rays corresponding to the cathode *d*, but as they appear when the tube is bent this cannot be their origin. It is especially to be noticed that the anode rays do not appear unless iodine, bromine, or chlorine is in the tube. This is perhaps due to the fact that the atoms of these substances are excellent traps for electrons which unite readily with halogen atoms. Any positively electrified particles in the tube will thus have a much better chance to escape being neutralized by these electrons when these gases are present than when they are absent: and thus the number of anode rays will be increased.

The most natural explanation of these rays is that the hot salts from which they originate act like fused electrolytes, and that the current through them into the discharge tube is carried by the ions into which the salts dissociate, the positive ion, which is a charged atom of the metallic constituent of the salt, following the current will come to the surface of the glow-

ing anode, will get detached from it, and under the influence of the strong electric field which exists gas close to the anode will acquire the high velocity characteristic of the anode rays.

Goldstein (*Monatsber. d. Berl. Akad.*, 1876: "Ver. der Deutsch. Physik Gesellsch.," 20, 123, 1918) and Gouy ("C. R.," 1909, p. 148) have observed rays proceeding from the anode in a discharge tube when the anode is in a strong magnetic field. These rays produce luminosity in the gas, and phosphorescence on the walls of the discharge tube.

There is in this case a great fall in potential close to the anode. We can understand why this should occur, for as the magnetic field would stop the electrons coming up to the anode, the only systems available for carrying the current would be positive ions. These would have to be produced close to the anode, and this would require a strong electric field; unless this was available the current must stop.

The presence of halogens, which, as we have seen, facilitates the formation of anode rays, also produces a strong field near the anode; this, like the effect of the magnet, is probably due to the withdrawal of electrons from the neighbourhood of the anode. The magnet effects this by sweeping the electrons to one side, the halogens by absorbing the electrons. We might, I think, expect to get rays coming from the anode whenever the conditions are such that electrons are prevented from reaching it. An analysis of the anode rays by the methods used for positive rays might be expected to lead to very interesting results.

G. P. Thomson ("Proc. Camb. Phil. Soc.," 20, p. 210) has shown that the anode rays can be analysed and the value of e/m determined by the photographic method used for positive rays, and Dempster ("Phys. Review," 2, 11, p. 316, 1918) has applied the electrical method (p. 120) for the same purpose.

DOPPLER EFFECT SHOWN BY THE POSITIVE RAYS

Before the methods described in the earlier part of this book had been fully developed, Stark¹ had discovered a property of the positive rays which is of great importance in connexion with the origin of spectra, and incidentally has led to results which have confirmed some of those obtained by the newer methods.

Stark's discovery resulted from the spectroscopic examination of the light produced by the positive rays passing through a gas at a pressure comparable with 1 mm. of mercury, a very much higher pressure than that used in the majority of the experiments when positive rays are studied with the help of the photographic plate or the willemite screen. The stream of rays passing through a perforated cathode produces at these high pressures considerable luminosity in the gas behind the cathode. Stark examined with a spectroscope this luminosity when the gas was hydrogen : (1) when the line of sight was at right angles to the direction of the rays ; (2) when the line of sight was approximately in the direction of the rays. In the first case he found that the series lines for hydrogen were in their normal positions. In the second, however, he found that though there were lines in the normal positions, these lines were broadened out towards the violet end of the spectrum when the positive particles were approaching the spectroscope, and towards the red end

¹ Stark, "Physik. Zeitschr.," 6, p. 892, 1905. "Ann. d. Phys.," 21, p. 514, 1906.

when they were receding away from it, indicating that some, though not all, of the systems emitting these lines were moving in the direction of the rays with velocities sufficient to give an appreciable Doppler effect. A closer examination of these lines brought out some interesting details which are illustrated in Fig. 2, Plate IV., taken from a photograph by Stark of the hydrogen line $H\gamma$. It will be noticed that though the displaced line is broadened out into a band, this band does not begin at the undisplaced position of the line, but is separated from it by a finite distance. The alteration $\Delta\lambda$ in the wave length λ of a line given out by a source moving towards the observer with a velocity v is by Doppler's principle given by the equation

$$\frac{\Delta\lambda}{\lambda} = \frac{v}{c}$$

where c is the velocity of light. In the case of these small displacements we may take, when we are dealing with one line in the spectrum, $\Delta\lambda$ as proportional to the displacement of the line, and we may use this equation to determine v the velocity of the particle emitting the line. The fact that the fine line is displaced into a broad band shows that these velocities range over somewhat widely separated limits: this is quite in accordance with the results indicated by the photographs of the positive rays when deflected by electric and magnetic forces. We saw that the parabolic arcs were of considerable length, and therefore were produced by particles moving with a wide range of velocities. The dark space between the undisplaced line and the band indicates that the moving particles do not give out the lines unless the velocity exceeds a certain value. As this occurs when the spectrum of the positive rays is observed when the rays are on their way to the cathode as well as after they have passed through

the openings in the cathode, it cannot be due to the absorption of the more slowly moving rays after they pass through the cathode. According to Stark and Steubing¹ this limiting velocity varies with the different lines of the same element, increasing as the wave length diminishes. The limiting velocity given by these observers for the hydrogen lines are as follows :—

$$H\alpha = 1.07 \times 10^7 \text{cm.} \quad H\beta = 1.26 \times 10^7 \text{cm./sec.}$$

These values are approximately proportional to the square root of the frequency of the lines. There is some difference of opinion as to whether this limiting velocity does or does not depend upon the frequency of the light. Paschen² came to the conclusion that it was the same for all the hydrogen lines. This velocity is small compared with the average velocity of the positive rays of hydrogen ; it corresponds to a fall through a potential difference of less than 100 volts. It is comparable in value with that which the mercury atom acquired in many of the experiments represented by the preceding photographs, when it had possessed one, but only one, charge throughout its journey through the discharge tube. The maximum displacement of the line depends to some extent on the potential difference between the terminals of the discharge tube ; but it does not increase nearly so quickly as the square root of that potential difference, as we should expect if the most rapidly moving particles could give out the line: the relation between the displacement and the potential difference is given in the following table due to Stark and Steubing.³ In this table r is the ratio of the kinetic energy of a particle moving with a velocity v , calculated by the Doppler formula (p. 149) from the maximum displacement,

¹ "Ann. der Phys.," 28, p. 974. ² *Ibid.*, 27, p. 599. ³ *Ibid.*, 28, p. 974.

to the kinetic energy the particle would possess if it fell when carrying one charge through the potential difference between the terminals of the discharge tube.

Potential difference in Volts.	r .
390	'907
425	'563
555	'824
600	'716
1200	'622
3000	'358
4000	'309
4000	'402
7000	'274

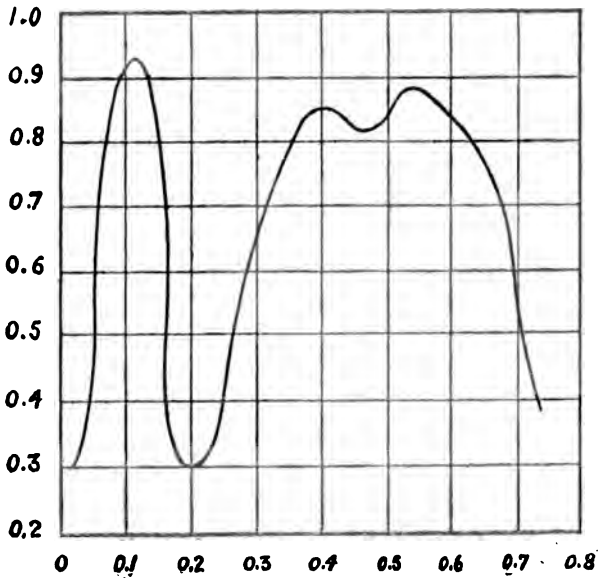


FIG. 42.

Stark indeed suggests that his observations are compatible with the view that the deflections approach a limit corresponding to a velocity about 1.5×10^8 cm./sec. and do not exceed this however large the potential difference between the terminals in the discharge tube may be. The distribution of intensity in the displaced line is very complicated and seems to be affected by the purity of the gas as well as by the potential difference between the terminals in the discharge tube. Paschen¹ was the first to observe that there are in some cases two maxima of intensity in the displaced line, and this has been confirmed by the experiments of Stark and Steubing² and of Strasser.³ The distribution of energy determined by Hartmann's microphotometer of the H γ line in very pure hydrogen is shown in Fig. 42, taken from Strasser's paper. The first peak represents the intensity of the undeflected line, the other two the intensities of the deflected. Gehrcke and Reichenheim⁴ have suggested that the atom and the molecule of hydrogen give out the same line spectrum, and that the most deflected maximum is due to the atoms, the other to the molecules. If the atom and the molecule acquired the same kinetic energy by falling through the potential difference between the terminals of the discharge tube, the velocity of the atom would be $\sqrt{2}$ times that of the molecule, and Gehrcke and Reichenheim found in the plates that came under their observation that the ratio of the displacements of the two maxima was approximately equal to $\sqrt{2}$. This, however, does not seem by any means always to be the case, as the following table, taken from a paper by Stark,⁵ of the results obtained by different observers, shows.

¹ "Ann. der Phys.," 23, p. 247, 1907.

² *Ibid.*, 28, 978.

³ *Ibid.*, 31, 890, 1910.

⁴ "Verh. d. Deutsch. Phys. Ges.," 12, p. 414, 1910.

⁵ *Ibid.*, 12, p. 711, 1910.

RATIO OF DISPLACEMENTS OF THE TWO MAXIMA.

	Observer.
1.75	Stark and Steubing
1.65	Paschen
1.58	Paschen
1.50	Stark and Steubing
1.63	Paschen
1.45	Strasser
1.40	Strasser
1.37	Stark and Steubing.

The photographs taken of the positive rays under electric and magnetic forces show also that in certain cases the velocities of the particles are grouped round certain values, for we find that some of the parabolas have a very decided beaded appearance: each bead corresponds to a group of particles moving with pretty nearly the same velocity. An example of this is shown in Fig. 3, Plate I. The intensity curve corresponding to the Doppler effect ought to have the same type of variations in intensity as these parabolas, and a beaded parabola ought to give rise to a Doppler curve with as many maxima as there are beads on the parabola. Sometimes these beads on the parabolas are quite numerous.

It is remarkable that the parabola corresponding to the atom of hydrogen is often beaded in such a way that the velocity of the particles producing one bead is to that producing the other as $\sqrt{2}:1$. Thus to explain the maxima in the Doppler curve with displacements in this proportion it is not necessary to assume that the molecules give out the same spectrum as the atom. The occurrence of singly charged atoms of hydrogen with velocities in this proportion of $\sqrt{2}$ to 1 might be accounted for in some such way as the following: the atoms with the larger velocity have been charged atoms

during the whole of their career ; they were atoms before they passed through the cathode and continue in this state after emerging from it ; the atoms with the smaller velocity were part of a charged molecule before passing through the cathode ; the molecule would only acquire a velocity $1/\sqrt{2}$ that of the atom. After passing through the cathode and before being deflected by the electric and magnetic fields this charged molecule breaks up into two atoms, one with a positive charge while the other is uncharged.

The Doppler effect we have been considering is that shown by the "series spectrum" of hydrogen. In addition to this spectrum, hydrogen gives a second spectrum containing a great number of lines, and this spectrum is developed, though not so brightly as the series spectrum, when positive rays pass through hydrogen. Stark¹ has shown, and his results have been confirmed by Wilsar,² that the lines in the second spectrum of hydrogen do not show the Doppler effect with the positive rays. We infer from this that the second spectrum of hydrogen is not due to any of the constituents of the positive rays, which were present in Stark's or Wilsar's experiments. We shall return to the question of the origin of the second spectrum later on.

Another illustration is the case of oxygen. Oxygen gives a series spectrum, a spark spectrum which has not been resolved into series, and some banded spectra. All these spectra are emitted when oxygen positive rays pass through oxygen, the spark spectrum being the brightest. With oxygen it is the spark lines that show the Doppler effect. Wilsar and Paschen could not detect any such effect with the series lines. Stark, however, who used very large dispersions, found the effect in some of the lines ; the intensity of the displaced

¹ Stark, "Ann. der Phys.," 21, p. 425, 1906.

² "Ann. der Phys.," 39, p. 1251, 1912.

lines was, however, very small compared with that of the undisplaced lines, while in the spark lines the displaced intensity¹ is quite comparable with the normal intensity.

Nitrogen has a line spectrum which has not been resolved into series, and some banded spectra. The linespectrum and one of the banded spectra are found where nitrogen positive rays go through nitrogen; the banded spectrum does not show the Doppler effect. Some of the lines in the line spectrum show it very distinctly, while it is quite absent from others (Herman, Wilsar). A very interesting point about the effect in nitrogen is that even for those lines which show the effect the value of $\Delta\lambda/\lambda$ is not constant. Wilsar² gives the following table for the Doppler effect for some of the nitrogen lines:—

Wave Length.	$\Delta\lambda/\lambda$.
5002·9	11·4
4643·4	10·35
4630·9	10·14
4530·3	10·60
3995·2	6·90

Thus the effect for the line 3995·2 is much less than for any of the others, showing that the velocity of the source of this line is considerably less than that of the sources of the others. The different states in which nitrogen occurs in the positive rays are atoms with two charges, atoms with one charge, molecules with one charge, and in exceptional cases atoms with three charges and a tri-atomic molecule with one charge. If the majority of the lines were given out by the doubly charged atom, and the line 3995·2 by the singly charged one, we should get relative values of $\Delta\lambda/\lambda$, approximately equal to those in the preceding table.

¹ Paschen, "Ann. der Phys.," 23, p. 261, 1907.

² "Phys. Zeit.," 7, p. 568, 1906.

The difference between the spectrum of the gas through which the rays pass, which does not show the Doppler effect, and that due to the positive rays themselves which does show this effect, raises some very interesting and fundamental questions with regard to the origin of spectra. The point can perhaps be illustrated most clearly by taking a special case, that of hydrogen, where, as Stark has shown, the lines of the second spectrum are found in the spectrum of the gas through which the rays pass but not in that of the rays themselves. Since in the positive rays we have both atoms and molecules of hydrogen changing backwards and forwards between the charged and the uncharged states we have in the rays all the forms in which hydrogen exists in the gas through which they pass, and yet this gas gives the second spectrum while the positive rays do not. It is however possible and indeed probable that the proportion of molecules to atoms in the positive rays in Stark's experiments was smaller than in the experiments in which the parabolas due to the positive rays were photographed. In his experiments the pressure had to be so high that the path of the positive rays was sufficiently luminous to allow the spectrum to be photographed, while in my experiments the pressure was so low that the path of the rays was not appreciably luminous. The proportion of charged molecules to charged atoms in the positive rays increases as the pressure diminishes; so that it is to be expected that the charged atoms in Stark's experiments were more numerous than the charged molecules, and thus if the second spectrum were due to the charged molecules it would in the spectrum of the moving gas be faint compared with that due to the atoms. The proportion between charged molecules and charged atoms in the positive rays depends on the pressure in the discharge tube, the luminosity on the pressure in the observation chamber, so that if we arrange that the pressure

in the discharge tube is low while that in the observation chamber is high the moving gas should, if this explanation is correct, show the second spectrum as well as the four-line one. There is, however, another way in which the second spectrum might arise. We know that the impact of positive rays against matter produces streams of slow cathode rays whose energy is comparable with that due to the fall of the atomic charge through a potential difference of about 20 volts. Thus the hydrogen through which the rays pass may be traversed by slow cathode rays due to the impact of the positive rays against the hydrogen molecules. Fulcher (*"Astrophysical Journ.,"* 34, p. 388, 1911) has shown that the second spectrum of hydrogen is excited readily by slow cathode rays. If the second spectrum observed in connexion with positive rays arose in this way, the ratio of the intensity of this spectrum coming from the positive rays themselves to that coming from the gas through which these rays are passing would be as the ratio of the number of particles in the positive rays to the number of molecules of hydrogen in the gas through which they passed. As this ratio is exceedingly small, the second spectrum would arise almost entirely from the gas at rest and so would not show the Doppler effect.

Passing from the case of hydrogen to that of oxygen or nitrogen we find in the spectra of those gases lines which do not show the Doppler effect. Similar considerations to those given for hydrogen apply here, and again many of the lines which do not show this effect are those which Fulcher finds are excited by slow cathode rays. Vegard has, however (*"Ann. der Phys.,"* 41, p. 625), pointed out that for nitrogen the lines which do not show the Doppler effect differ materially from those produced by slow cathode rays, so that the presumption is that such lines are due to molecules of nitrogen which may not, at the high pressures required to

get sufficient luminosity, form an appreciable portion of the positive rays.

When there are traces of compound gases in the discharge tube the spectrum of an element which enters into one of these compounds may show anomalous Doppler effects. Let us suppose, for example, that the discharge tube contains hydrogen mixed with a little hydrochloric acid. Then the gas which has passed through the cathode may be expected to contain the following types of hydrogen atoms :

1. Atoms which were atoms before they passed through the cathode.

2. Atoms which before passing through the cathode formed part of a molecule of hydrogen which dissociated into atoms after passing through the cathode.

3. Atoms which before passing through the cathode formed part of a molecule of hydrochloric acid which dissociated into atoms after passing through the cathode.

If the energies of the atom, of the molecule of hydrogen and of HCl on reaching the cathode were equal, as we should expect from the properties of the positive rays, then the velocities of the three types of hydrogen atoms will be respectively

$$V, V/\sqrt{2}, V/\sqrt{36.5}.$$

Thus an atom which had been dissociated from a molecule after passing through the cathode would have the same velocity as the molecule, and the Doppler effects for its spectrum would be the same as for the spectrum of the molecule, supposing the latter to be capable of giving out a spectrum. We thus cannot distinguish between molecular and atomic spectra by the Doppler effect alone. Stark ("Phys. Zeits.," 14, p. 770, 1915) has assigned one of the series spectra of oxygen to the oxygen molecule. As we have

seen, the argument from the Doppler effect is not conclusive but the question raises a very interesting point as to what kind of spectrum is emitted by the molecules which in many cases form a large part of the positive rays. It is true that in our experiments on the photography of these rays the molecules are probably much more numerous than they are in the experiments which are made on the spectra of the positive rays, where the pressure is much higher, for the proportion of molecules to atoms diminishes as the pressure increases. The molecular spectrum might be brightened by having the observation chamber at a higher pressure and the discharge chamber at the same pressure as in the photographic experiments. It is accepted almost as an axiom in spectroscopy that line spectra are due to atoms and band spectra to molecules, and there is certainly a large volume of evidence from experiments in support of this view. I do not think that we could on theoretical grounds exclude the possibility of a molecule giving a line spectrum. A band spectrum is usually regarded as being given out by a series of oscillators which are not all in identical conditions, but exposed to variations which are spread almost uniformly over a certain range. Thus, to take a concrete case, we may suppose that, in consequence of the centrifugal force due to the energy the molecules possess, the distance between the atoms in a molecule is a function of their energy of rotation. As this energy is not constant for the various molecules of a gas, but is distributed according to Maxwell's law of distribution, the distances between the atoms in a molecule will not be fixed but will vary continuously within certain limits. If the frequencies of vibration of a molecule depends on the distance between the atoms, the spectrum given out by the molecules would be a series of bands whose width would depend on the extent to which the frequencies are affected by alteration in

the distance between the atoms. If the alteration in frequency were very small these bands would thin down into lines and the spectrum would be of the same type as one due to an atom. The above is merely given as an illustration. I do not mean to suggest that band spectra arise in this way, in fact I think it is clear they do not, for if they did, since the average distance between the atoms in a molecule would be a function of the temperature, the position of the bands would vary with the temperature. The fact that in the great majority of cases there is no evidence of this shows that the kinetic energy possessed by the molecule has a negligible effect on the spectrum. But if we can rule out in the consideration of spectra the effect of the rotational energy of the molecule, the molecule has as definite a configuration as the atom, and might be expected to give out as well-defined system of lines. We cannot, I think, on theoretical considerations, rule out a line spectrum from a molecule as impossible, whether such has been observed is another matter. Since by the methods of positive-ray analysis we can separate the atoms from the molecules we have the means of separating the two spectra.

G. P. Thomson ("Phil. Mag.," Aug. 1920) has shown that when the parabola due to the hydrogen molecule in the positive-ray spectrum is faint compared with that due to the hydrogen atom, the rays do not show the second spectrum of hydrogen, and that this spectrum appears when the parabola due to the molecule is comparable in intensity with that due to the atom. This points to the hydrogen molecule as the source of the second spectrum, a conclusion at which Stark ("Ann. der Physik." 52, p. 221, 1917) had arrived from the study of the spectrum of the positive column.

There is one type of vibration of an electrical system which has, I think, not received as much attention as it deserves in connection with the radiation emitted by luminous

gases. The vibrations hitherto considered have been those of electrical changes, of electrons for visible and ultra-violet radiations and of positive charges for those in the infra-red. There is, however, another possible type of vibration which is not dependent on the motion of electrical charges, but on the motion of the tubes of force which bind those charges together.

Suppose, for example, that A and B are two oppositely charged bodies with their charges held rigidly in a fixed position. When in equilibrium the lines of force would be distributed in a definite way which can be deduced from the laws of Electrostatics. Now let this distribution be suddenly disturbed by the passage through the field of a very rapidly moving electric charge. The lines of force will be disturbed from their equilibrium position where the potential energy is a minimum, and after the moving charge has passed away they will vibrate about this position. The possible times of vibration of such a complex system would probably be very numerous and would be multiples or sub-multiples of D/c when D is the distance between A and B and c the velocity of light. This is on the supposition that there are no bodies in the neighbourhood of AB which when the electric field is changing can be set in motion and absorb energy. The wave length of the vibrations would thus be comparable with D , the distance between the charges, and if these conditions applied to atoms and molecules the wave lengths of such vibrations would be comparable with the diameters of atoms and molecules, and so would not correspond with visible or even ultra-violet light. In atoms and molecules, however, the lines of force do not spread out through an empty field: the space near the centre of an atom is crowded with electrons whose free vibrations are exceedingly rapid; these electrons will be affected by the lines of force in the vibrating electric

field and will increase the time of its vibrations. In addition to the electrons near the centre there are others near the surface whose position relative to the two bodies A and B may vary from one molecule or atom to the other. These may be regarded as coupled up with the primary system, the stiffness of the coupling varying from one molecule or atom to another. The effect of this coupling on the period of vibration may be got by the use of the principle that when two vibrating systems are coupled the quicker vibration of the two is made quicker and the slower slower. Thus the effect of the outside electron on the vibrations of the primary system (including in this the effect produced by the inner electrons) will be to quicken the vibration (i.e. to shift the corresponding line to the blue end of the spectrum), if the period of vibration of the surface electron is longer than that of the primary system. The amount of the shift will depend upon the firmness of the coupling, and if this varies from atom to atom, or from molecule to molecule, the spectra corresponding to these vibrations will be a band with the sharp end at the red end of the band, this end of the band having the period corresponding to indefinitely small coupling. If the period of the surface electron is smaller than that of the primary system, the vibrations of this system will be slowed down by the coupling and the spectrum would have a band with its sharp end at the blue end of the band.

The effect of a magnetic field would, on a spectrum produced in this way, be very much less than on one produced primarily by the motion of an electron. For though the magnetic field would modify the time of vibration of the surface electron and thus affect to a small extent the effect produced by the coupling, the effect on the vibration of the whole system would be of the nature of a correction on a correction, and therefore much smaller than the direct effect

produced on the vibration of the surface electron itself. In this respect these spectra would behave like "band" spectra, which are far less susceptible to the action of a magnetic field than the series spectra. Vibrations of the kind we are considering might occur in atoms as well as in molecules, their intensity and character might be expected to depend to a considerable extent upon whether the atom was charged or not. The radiation from atoms is not confined to line spectra, as we know that band spectra are given out even by a monatomic gas like mercury.

The reflection of hydrogen and, to some extent, of helium positive rays has been detected by observations of the Doppler effect (Stark and Steubing, "Ann. der Phys.," 28, p. 995, 1909; Stark, *ibid.*, 42, p. 231, 1913). The reflected rays are few in number, compared with the incident ones, and their velocity is very much less. The reflection is more pronounced with slow rays (corresponding to a fall of potential of 5000 volts or so) than with fast ones. No reflection has been detected with certainty for positive rays from the heavier elements, though Stark has looked for it in C, O, Al, S, Cl, Ar, I, Hg: with the rays from mercury there were indications of an exceedingly faint reflection, not enough, however, to establish the result with certainty. It is to be remembered, however, that the retrograde rays (see p. 134) would give rise to Doppler effects of the same character as reflected positive rays. In discussing this subject it is necessary to have clear ideas as to the meaning we attach to "reflection": if by reflection of a positive ray we mean that a ray has rebounded without any transformation of its electrical condition, it cannot, I think, be maintained that reflection has been established.

The lines in the spectrum given out by the positive rays which show abnormally large Doppler effects, and which are

due to atoms with multiple charges, are found in the spectrum of the stationary gas through which the rays are passing as well as in that of the positive rays themselves. This is important in connection with the origin of atoms of this type, as since no fast cathode rays are passing through this gas, such rays can not be essential for the production of multiple charges. Thus positive rays must be able to produce them. The quicker the rays the more capable they seem of producing doubly instead of singly charged atoms. Thus in oxygen Stark (*Ann. der Phys.*, 42, p. 163, 1913) found that with 3000-volt rays the spectrum due to the singly charged atoms was vastly brighter than that due to the doubly charged ones, the latter spectrum increased markedly in intensity when the voltage was raised to 7500 volts, while with 15,000-volt rays it was brighter than that due to the singly charged atoms. Stark has by this method detected atoms of aluminium with 1, 2 and 3 charges, and atoms of mercury with 1, 2, 3 and 4. We saw on p. 80 that the mercury atom occurs in the positive rays with as many as seven charges.

It would be interesting to compare the ratio of intensities of the lines in the spectrum of the positive rays due to the singly and doubly charged atoms respectively with the same ratio in the spectrum of the gas through which the rays are passing. Vegard (*Ann. der Phys.*, 39, p. 111, 1912; 42, p. 625, 1913) has measured the relative intensities in the two spectra of some hydrogen, oxygen and nitrogen lines, but his measurements do not include lines due to doubly charged atoms, there are, of course, none of these in the hydrogen spectrum; he finds that there are great variations in the relative intensities of the lines which show the Doppler effect and those which do not, when the pressure of the gas or the potential difference is altered. This is what we should expect, as we know that the proportion between the different

types of particles in the positive rays—atoms, molecules, singly and doubly charged atoms—is also dependent upon the pressure and the potential difference. Experiments on the spectra produced by rays whose composition has been determined by electric and magnetic deflection would probably lead to much more definite knowledge of the sources of the various lines in the spectrum.

POLARIZATION OF THE LIGHT FROM POSITIVE RAYS

Stark and Lunelund (*Ann. der Phys.*, 46, p. 68, 1914) have shown that the light given out by positive hydrogen rays is partially polarized. The light which has the electric force in the direction of motion of the rays being more intense than the light with the electric force at right angles to this direction. No polarization was detected in the light which does not show the Doppler effect and which comes from the gas through which the positive rays are passing.

Since close to a positive ray particle there is a strong magnetic field due to the motion of the electric charge, an electron returning to the particle will be deflected, and thus the line joining the centre of the atom to the captured electron will be more likely to make one angle rather than another with the direction of motion. The directions of those lines will not be uniformly distributed, and as the direction of the electric force emitted by the vibrating electron will depend upon the direction of the line, we should expect the light emitted by these moving particles to show polarization.

Stark's experiments have shown that the source of the series lines is one of the constituents of the positive rays: the question is, which constituent? We have seen that in hydrogen,

for example, we have positively and negatively charged atoms, as well as neutral ones: we have also positively charged and neutral molecules. There is considerable difference of opinion as to which of these is responsible for the series lines in the hydrogen spectrum. All theories concur in regarding the atom and not the molecule as the source of these lines, but according to Wien's theory the atom radiates when in the neutral state, while Stark maintains that the radiation is emitted when the atom has a positive charge: according to his view, the lines emitted by the neutral atom are far away in the ultra-violet.

The pressures at which spectroscopic observations have been made are so high that an atom is continually passing backwards and forwards between the neutral and charged conditions. It is thus a matter of great difficulty to determine whether the atom emits the lines in one state or the other, and there is, I think, at present no experiment which is absolutely decisive between the two views. Thus, for example, it is found that the Doppler effect is increased when the positive rays are exposed to an accelerating potential after passing through the cathode. This, however, does not prove that the particles are charged when giving out the light, for the particles which are uncharged at one time have at other times a positive charge and so would be accelerated.

Perhaps the strongest argument in favour of the radiating particles being positively charged is that in certain cases, as Reichenheim has shown, the anode rays (see p. 142) show the Doppler effect, but even this is not conclusive, as some of the positively charged particles might have been neutralized after they had acquired their high velocity under the electric field.

There is another view as to the origin of the radiation which explains in a simple way some of the characteristic properties of the Doppler effect: this is that the light is

given out by particles which have just been neutralized by union with an electron. The electron falls into the positively charged atom and the energy gained by the fall is radiated away as light. On this view the intensity of the light should vary with the number of recombinations of positive ions and electrons. Let n be at any instant the number of neutral particles per unit volume moving with velocity v , p the number of positive particles moving with the same velocity, N the number of electrons per unit volume, whether free or in the atoms which are in the track of these particles.

Then the number of recombinations per second will be

$$pNf(v)$$

when $f(v)$ is a function of v which will vanish when v is very large, for recombination will not take place if the relative velocity of the positive particle and the electron exceeds a certain value.

The number of neutral particles ionized per second will be

$$nNF(v)$$

where $F(v)$ is a function of v which vanishes when v is very small, for if the particle is to be ionized by a collision the relative velocity of the particle and electron must exceed a critical value.

When the composition of the beam of positive rays has become steady the number of ionizations must equal the number of recombinations, hence

$$\begin{aligned} pNf(v) &= nNF(v) \\ \text{and therefore} \quad &= \frac{(p+n)Nf(v)F(v)}{f(v)+F(v)} \end{aligned}$$

Since $f(v)=0$ when $v=\text{infinity}$ and $F(v)=0$ when $v=0$, $f(v)F(v)$ will have a maximum for a certain value of v which will not however depend on the potential difference between the electrodes in the discharge tube. The factor $p+n$, the total number of positive rays charged or neutral whose velocity

is v , will also be a function of v , and this function will depend upon the value of E , the potential difference between the electrodes in the discharge tube, for evidently if E increases, the value of v for which $p + n$ is a maximum will increase too.

On the view we are considering, the intensity of the light showing a Doppler effect corresponding to the value v will be proportional to the number of recombinations of positive ions moving with this velocity with electrons. It will thus be proportional to $pNf(v)$ which we have seen is equal to

$$(p + n) \left\{ \frac{f(v)F(v)}{f(v) + F(v)} \right\} N$$

The second factor in this expression

$$\frac{f(v)F(v)}{f(v) + F(v)}$$

has its maximum value for a value of v which does not depend upon the potential difference: the other factor ($p + n$) does depend upon this potential difference. Thus the value of v for which the product of these factors is a maximum will depend to some extent on E , but since the value of v which makes one of the factors a maximum is quite independent of E we should expect that a variation in E would have less effect on this velocity than on the average velocity of the particles in the positive rays.

Again since $F(v)$ vanishes when v is less than a certain value v_0 , there will be no light showing a Doppler effect corresponding to a velocity less than v_0 , thus there will be a dark space between the original line and the displaced lines. This also is in accordance with the observations. Since $f(v)$ vanishes when v is greater than a certain value v_1 , there will be no Doppler effect showing a greater displacement than that corresponding to v . Though this has not perhaps been absolutely proved there are indications that the Doppler

effect cannot be increased beyond a certain definite value, however large the potential applied to the discharge tube may be.

When positive rays produced in a gas A pass through a gas B the spectra of both A and B are given out: Wilsar, "Phys. Zeitschr.," 12, p. 1091, and Fulcher (*ibid.* 13, p. 224), have shown that all the lines of A are displaced while all those of B are in their normal position. A bibliography of the Doppler effect in the Positive Rays has been published by Fulcher, "Jahrb. d. Radioaktivität," X, p. 82, 1913.

SPECTRA PRODUCED BY BOMBARDMENT WITH POSITIVE RAYS

The spectra produced when the positive rays strike salts of the alkali metals are very interesting. The salts give out the lines of the alkali; for example, Li Cl give out the red lithium line and sodium salts the D line. It is remarkable that the lines due to the metal are more easily excited in the salts than in the metal itself. Thus if the liquid alloy of sodium and potassium is bombarded by positive rays the specks of oxide on the surface glow brightly with the sodium light while the clean surface remains quite dark. Some observers have noticed what seems a similar effect with hydrogen, viz. that the hydrogen lines are more easily excited in water vapour than in pure hydrogen. The fact that in the positive ray photographs, the parabolas corresponding to a certain type of ray, for example the carbon or oxygen atom with two charges, is more easily developed from compounds than from the molecules of the gases themselves, is probably connected with this effect.

The production of spectra by bombardment with cathode rays has been investigated by Gyllensköld ("Ark. f. Math.

Ast. oet. Fys.," 4, No. 33, 1908), and by Stark and Wendt ("Ann. der Phys.," 38, p. 669, 1912), who have shown that the colourless salts of the alkalies and alkaline earths and also of thallium, zinc, and aluminium give out the series lines of the metal when struck by the positive rays, and that the lines given out do not depend upon the character of the salts. According to Stark and Wendt the seat of the emission is not the surface of the salt itself but a layer of gas, less than 1 mm. thick, close to the surface. This is what might have been expected, for to get a line spectrum we must have the substance in the gaseous state. This layer is analogous to the velvety glow which covers the surface of the cathode where an electric discharge passes through a gas at a low pressure.

To develop the spectrum of the metal the positive rays must have more than a certain critical amount of energy depending on the nature of the salt. The values of V, this critical energy, measured by the number of volts through which the atomic charge must fall to acquire it, have been measured by Stark and Wendt and are given in the following table:—

Metal.	Salt.	Light given out.	V.
Lithium	chloride	red	600
Lithium	oxide	red	600
Lithium	oxide	λ 671	<800
Sodium	chloride	yellow light	750
Potassium	chloride and oxide	λ 580	<2400
Rubidium	sub-oxide	λ 572	<3500
Cæsium	chloride	λ 566	<4500
Magnesium	chloride	λ 518	<1200
Calcium	fluoride	red violet light	1500
	carbonate	red violet light	1500
	sulphate	red violet light	1500
	oxide	red violet light	1400
Strontium	chloride	λ 496	<2500
Barium	chloride	λ 554-493	<2500
Thallium	sulphate	λ 535	4500
Aluminium	oxide	λ 396	<4500
Zinc	oxide	λ 475	<4600

It must not be supposed that the amounts of energy given in the last column represent the minimum amount required to excite the particular kind of light given in the third column. When energy has to be transferred from a charged atom to an electron, the latter only receives a very small fraction of the energy of the atom, thus a very small fraction of the energy of the positive rays may be transformed into a kind available for light production.

Gyllensköld observed that in addition to the D lines sodium chloride gives out a series of bands in the blue, and Stark and Wendt have shown that for this to occur the energy of the rays must exceed a critical value which in most cases is less than that required to excite the line spectrum.

Ohlon (*"Verh. Deutsch. Phys. Gesell.,"* 20, p. 9, 1918) found that if the salt was placed in a metal vessel connected with earth through a galvanometer the positive current through the galvanometer due to the impact of the positive rays diminished abruptly when the potential reached the value at which the line spectrum was emitted; the most obvious explanation of this is that the conductivity of the gas round the vessel is suddenly increased.

As the salt has to be vaporized before it can emit the line spectrum the excitation of these spectra by positive rays is closely connected with that of "electrical evaporation," which is considered in the next paragraph.

DISINTEGRATION OF METALS UNDER THE ACTION OF POSITIVE RAYS

When positive rays strike against a metallic surface, the metal disintegrates and forms a deposit on the walls of the tube surrounding the metal. A well-known instance of

this is the "spluttering" of the cathode in a vacuum tube; another is observed when working with an apparatus like that shown in Fig. 14; after long use the thin metal tube which passes through the cathode gets worn away at the end nearest the discharge tube, as if it had been struck by a sand blast. Sometimes several millimetres of the tube are destroyed in this way. An excellent account of the very numerous experiments which have been made on the spluttering of the cathode will be found in a report by Kohlschütter ("Jahrbuch der Radioaktivität," July 1912).

The spluttering due to the impact of positive rays is not confined to metals: Stark and Wendt ("Ann. der Phys.," 38, p. 921, 1912) found that it occurred in quartz, rock salt, glass and mica. In all these substances, with the exception of quartz, long exposure to the positive rays produces a kind of blistering on the surface which seems to be due to the positive rays penetrating a finite distance into the substance and remaining there. This effect was not shown by the positive rays of the heavy elements such as mercury. The penetration seems connected with the "hardness" of the surfaces struck. Goldsmith ("Phoenix, Phys. Lab. Contrib.," No. 26, 1911) found that the positive rays of hydrogen and helium could pass through plates of mica .002 — .006 mm. thick.

Rausch v. Traubenberg ("Göttingen Math. Physik.," p. 272, 1914) separated the positive rays by electric and magnetic fields in the usual way and observed the fluorescence they produced on a fluorescent screen coated with gold leaf. He found that the hydrogen atom, the hydrogen molecule, and either the oxygen or nitrogen atom or both (the resolution was not sufficient to separate these lines) penetrated the gold leaf and produced fluorescence on the screen. The rays lost their electric charges while passing through the gold leaf.

The thickness of gold leaf through which the fluorescence due to the hydrogen atom could be observed was proportional to the velocity of the atom and was 36.6×10^{-6} cm. when the velocity was 2.6×10^8 cm./sec.

The experiments of Holborn and Austin, Granquist, and Kohlschütter indicate that with a constant current, w (the loss of weight in a given time) may be represented by a formula of the type

$$w = a \frac{A}{n} (V - S)$$

where V is the cathode fall of potential, A the atomic weight of the metal, n a small positive integer, and a and S quantities which are much the same for all metals, or at any rate the metals can be divided into large classes and a and S are the same for all the metals in one class. For a current of 6 milliamperes, Holborn and Austin found that for all the metals they tried S was 495 volts. We see that a formula of this type implies that there is no appreciable spluttering unless the cathode fall of potential exceeds a definite value S , and this seems to be verified by experience.

The experiments of Holborn and Austin, Kohlschütter and others have shown that this expression for the loss of weight of the cathode fails when V exceeds a certain value; for hydrogen this value seems to be so low that the expression fails before the loss of weight becomes measurable.

The loss of weights of the six metals Al, Fe, Cu, Pt, Ag, Au have been measured by Kohlschütter and Müller ("Zeit. schr. f. Elektroch.," 12, 365, 1906) and Kohlschütter and Goldschmidt (ibid. 14, 221, 1908) in the gases H_2 , He, N_2 , O_2 and Arg, under as nearly as possible identical electrical conditions. They found that for all gases the amount of weight lost was in the order in which the metals are written above, gold always losing the greatest amount and aluminium the

least. For the same metal in different gases the loss of weight followed the order of the atomic weight of the gases, the loss in hydrogen being least and that in argon greatest. This may be connected with the fact that (see p. 82) elements of high atomic weight acquire multiple charges of electricity more easily than the lighter elements, and atoms with a multiple charge have more energy when they strike against the cathode than those which have only one charge. The form of the equation for w shows that if instead of considering the loss of weight we consider the number of atoms lost by the cathode, the numbers should be in simple proportions for the different metals. This seems to be confirmed by some experiments of Kohlschütter on the loss of weight of Ag, Au, Pt, Pd, Cu, and Ni cathodes in nitrogen for the same current and cathode fall. He found that for each atom of Ag detached from a silver cathode one-half an atom of Au, Cu, Pd, one-third of an atom of Pt, and one one-fourth of an atom of Ni were detached from cathodes of these metals. The proportion was, however, not the same in argon as in nitrogen.

Kohlschütter and his collaborators ("Zeitschr. f. Elektroch.," 12, p. 365, 1906; 14, p. 221, 1908) have compared the loss of weight of a silver cathode due to spluttering with the weight of silver deposited in a silver voltameter placed in series with the discharge tubes. The results are shown in the following table.

Gas in discharge tube.	Loss of weight by spluttering.	Silver deposited in voltameter.
Hydrogen	·27	1·2
Helium	·4	1·2
Nitrogen	2·05	2·4
Oxygen	4·7	2·05
Argon	5·2	1·45

To answer the question how many atoms of silver are detached from the cathode when one positive ray strikes against it, we should require to know the proportion of current carried by the positive rays and the cathode rays respectively. We do not know this, but we have every reason to believe that the greater part of the current is carried by the cathode rays; if this is so, the table shows that every positive ray which strikes the cathode must on the average detach a large number of silver atoms from the cathode. Whatever the proportion between the currents carried by the positive and negative carriers may be, the table shows that, at any rate in oxygen and argon, each positive ray detaches more than one atom of silver. It may be that the mechanism by which the metal is torn from the cathode is such that the atoms of the metal are not liberated separately, but in groups. Thus, to take a purely mechanical view of the process we may suppose that the atom struck by a positive ray is driven further into the metal, that its displacement forces outwards the atoms in a ring surrounding it, and that these atoms acquire a considerable part of the energy in the positive ray. On this view the process would be analogous to that which occurs when a marble falls upon the surface of water, a crater is formed under the marble but the rim of the crater moves upwards and escapes, if the marble has fallen from a considerable height, from the surface of the liquid in drops. So in the case of the cathode it may be that it is not the atom struck by the positive ray which is torn from the metal, but a ring of atoms in its neighbourhood. It would follow from this that to disintegrate the cathode the positive ray must possess energy sufficient to tear away not merely one atom of the metal of the cathode, but the large number in the ring. The experiments alluded to above have shown that the disintegration of

the cathode is not apparent unless the energy of the positive ray is that due to the fall of the atomic charge through a potential difference of about 500 volts. We can calculate from the latent heat of evaporation the energy required to separate one atom from the surface of a metal, and this comes out less than that due to the fall of the atomic charge through 7 volts, a minute fraction of the 500 volts necessary to produce disintegration by positive rays.

There is, I think, something to be said for the view that the disintegration is effected by radiation produced by the impact of the positive rays, rather than by an atom acquiring a high velocity through being struck by a positive ray. I have shown (*"Phil. Mag.,"* 6, 28, p. 620, 1914) that radiation analogous to Röntgen radiation of an exceedingly soft type is produced where positive rays strike against a solid target so that radiation of the requisite type is available. Now Lenard and Wolf (*"Wied. Ann.,"* 37, p. 443, 1889); R. v. Helmholtz and F. Richarz (*"Wied. Ann.,"* 40, p. 187, 1890); Stark (*"Phys. Zeit.,"* 9, p. 894, 1908); Rubens and Ladenburg (*"Ber. d. Deutsch. Phys. Ges.,"* 9, p. 749, 1907) have shown that disintegration of metals occurs when ultra-violet light falls upon them.

We should expect that the wave lengths of the vibrations started by the impact of positive rays would be very much longer than those started by cathode rays possessing the same amount of energy. For if these vibrations arise from the motion of the electric charges carried by the rays, their frequency will depend on the time the movements of these charges are affected by an electric field through which they are passing. This time may be taken as inversely proportional to the velocity of the moving charges; thus, from this point of view, the frequencies of vibrations excited by positive and cathode rays moving with the same velocity, might be expected to be

of the same order. If we take this as a rough guide, then the frequencies of the vibrations excited by 500-volt positive rays in oxygen would be comparable with those excited by $\frac{1}{16} \cdot \frac{500}{1700}$ volt cathode rays. The wave length of the latter would, if calculated by Planck's rule, be about 64×10^{-4} cm. and would correspond to the infra-red part of the spectrum. If the molecules of the metal are arranged in regular order along a series of space lattices they would have definite times of vibrations, which might well, from what we know about absorption, correspond to the infra-red part of the spectrum. If any of these times of vibration corresponded with that of the radiation excited by the positive rays, the molecules might by resonance absorb sufficient energy to be able to escape from the metal. From this point of view there would be a lower and a higher limit to the energy of the positive rays which give rise to disintegration: a lower limit where the vibrations excited would be slower than those within the compass of the molecules of the metal; and a higher limit where the vibrations would be too quick to find a response in the metal.

Kohlschütter ("Zeitschr. Elektroch.," 18, p. 837, 1912) considers that the reason why a finite potential fall is required to effect the disintegration of the electrode, is that the vapour of the metal escaping from the cathode condenses into dust and would, unless it possessed more than a certain amount of energy, be dragged back into the cathode by the electrical forces in the neighbourhood of the cathode, and in this way disintegration would be prevented. It must be remembered, however, that though an increased cathode fall would increase the energy of the escaping vapour, it would also increase the forces tending to bring the metallic dust back to the cathode.

ABSORPTION OF GASES IN THE
DISCHARGE TUBE

The absorption of gases in discharge tubes may arise from many different causes: thus, for example, in some cases, notably those where incandescent filaments are used for cathodes, it is due to chemical action between the metal of the electrode and the gas. There is, however, a type of absorption which persists even after the tube has been used for a long time, and which has been called by Vegard, who has investigated it, "conservative absorption" which shows considerable analogy with the disintegration of the cathode. Vegard (*"Phil. Mag.,"* 6, 18, p. 465, 1909; *"Ann. der. Phys.,"* 50, p. 769, 1916) finds that this absorption, like disintegration, does not occur unless the potential fall exceeds a certain value, about 400 volts for platinum and 320 for gold. These voltages are about the normal cathode fall for these metals, so that this kind of absorption only begins when the current through the tube is large enough to make the cathode fall abnormal. The order of absorption for different metals seems roughly, at any rate, to be much the same as that for disintegration. This would be the case if the absorption were produced by the disintegrated metal, which is in a very fine state of division, and therefore provides a large surface for absorption.

Dechend and Hammer (*"Zeitschr. f. Elektroch.,"* 17, 235) allowed the positive rays produced in sulphuretted hydrogen to pass through a perforated cathode and after deflection by magnetic and electric fields to fall upon a plate of polished silver. They could detect the parabolas on the plate, but while the parabolas due to hydrogen were so faint that they could only be detected as breath figures, those due to the heavier atoms, presumably sulphur, had so affected the plate that they

could not be removed either by acid or rubbing. The greatest effect, however, was produced by the undeviated rays. In addition to the effects produced when the positive rays strike against a metal plate there is, as Schmidt has shown, a general oxidation over the surface when the metal is oxidizable and when the gas surrounding it contains oxygen. The passage of the positive rays through the oxygen produces atomic oxygen which is very active chemically and which attacks the plate. If, on the other hand, an oxidized plate is placed in hydrogen and exposed to the action of positive rays the oxide is reduced, the rays produce atomic hydrogen which acts as a strong reducing agent.

Some of the atoms constituting the positive rays seem to enter a metal against which they strike, and either combine with the metal or get absorbed by it. Helium, neon, and mercury vapour seem especially noticeable in this respect. If a cathode has once been used for any of these gases, positive rays corresponding to these elements will be found when the cathode is used with other gases, and it requires long-continued discharge and repeated fillings with other gases before they are eliminated.

A very valuable Bibliography of Researches on Positive Rays has been published by Fulcher (Smithsonian Miscellaneous Collection, 5, p. 295, 1909).

ON THE USE OF THE POSITIVE RAYS FOR CHEMICAL ANALYSIS

1. We shall now proceed to show how the method of positive rays supplies us with a very powerful method of chemical analysis, and how from the study of the positive-ray photographs we are able to determine the different kinds of atoms and molecules in the discharge tube. Each kind of

atom or molecule in the discharge tube produces a separate parabola on the photographic plate, and if we measure these parabolas then by means of the formula (p. 21)

$$\frac{e}{m} = \frac{y^2 A}{xB^2}$$

we can determine the value of e/m for the particles producing any parabolas. We know, too, that the charge e is either the ionic charge whose value on the electrostatic system of units is 4.8×10^{-10} , or some multiple of it. We have, too, as we shall see, the means of determining what this multiple is. As we can determine the value of e , and since we know by the measurement of the parabola the value of e/m , we can deduce the value of m and thus determine the masses of the particles forming the positive rays. As these particles are the atoms and molecules of the gases in the discharge tube it is evident that in this way we can determine the atomic or molecular weight of the gases in the positive rays. We can thus identify these gases as far as can be done by the knowledge of their atomic weight. The study of the photographs gives us in fact the atomic weights of the various gases in the tube, and thus enables us to determine the nature of its contents. We can thus analyse a gas by putting a small quantity of it into a discharge tube and taking a photograph of the positive rays. This method of analysis has many advantages. In the first place, as the pressure is very low, only a very small quantity of gas is required; the total amount of gas in the discharge tube of the size used in my experiments would only occupy about .01 c.c. at atmospheric pressure, and a constituent present to the extent of only a very small percentage would give well-defined parabolas. If there is a new gas in the tube it is indicated by the presence of a new parabola, but this parabola does far more than show that something new

is present, it tells us what is the atomic weight of the new constituent. Let us compare for a moment the method with that of spectrum analysis. We might detect a new gas by observing an unknown line in the spectrum when the electric discharge passed through the gas. This observation would, however, tell us nothing about the nature of the substance giving the new line, nor, indeed, whether it arose from a new substance at all: it might be a line given out by a well-known substance under new electrical conditions. Again, if a substance is only present to the extent of a few per cent. it very often happens that its spectrum is completely swamped by that of the more abundant substance: thus, for example, in a mixture of helium and hydrogen we cannot observe the helium lines unless the helium is a considerable percentage of the mixture.

This is not the case with the positive rays, or at any rate not to anything like the same extent; the presence of one per cent. of helium would be very easily detected by the positive rays. The method, too, is more sensitive than that of spectrum analysis. With the apparatus described above the helium in 1 c.c. of air, i.e. about 3×10^{-6} c.c., could be detected with great ease even when it formed only about one per cent. of the mixed gases in the tube. No special attention was paid to making this particular apparatus specially sensitive. To get the best results, the size of the tube running through the cathode has to be chosen with reference to the distance of the photographic plate from the cathode, and other circumstances; this was not done in the apparatus under discussion, nor were the photographic plates used of any special sensitiveness; by attention to these points the sensitiveness of the method could be increased very materially.

Again, the method of the positive rays enables us when we have found the substance to say whether the molecule is

monatomic or diatomic; if it is diatomic we shall have two new parabolas, one due to the atom and the other to the molecule; if the molecule is monatomic there will be only one parabola unless the particle acquires a double charge: the presence of this extra charge can be recognized by the tests previously described. The method of the positive rays has the advantage of revealing the presence of the molecules of compound gases as well as the atoms and molecules of elementary substances. Since different compounds may have the same molecular weight there is sometimes ambiguity in interpreting the photographs produced by the positive rays; for example, CO_2 and N_2O produce the same parabolas as also do CO and N_2 . In such cases to find out the origin of such a parabola we must repeat the experiment under different conditions; for example, if we put something in the tube which absorbs CO_2 and not N_2O , and find that the parabola disappears, we conclude that it was due to CO_2 ; if it does not disappear it is not due to CO_2 , but to N_2O or some other compound with the same molecular weight.

The ambiguity as to whether a line with a value of m/e equal say to 8 (m/e for the hydrogen atom being taken as unity) is to be ascribed to an atom with atomic weight 8 carrying a single charge, or to one with an atomic weight 16 carrying two charges, or to one with atomic weight 24 with three charges may be removed by the considerations given on page 77. For example, if the particle producing this parabola A carries a double charge there will be another and more intense parabola B, for which the value of m/e is twice that for A; and the parabola B will have a prolongation towards the vertical axis, the distance of the head of this prolongation from the vertical axis being half the distance of the heads of the normal parabolas. If A represents a particle with a threefold charge there will be another stronger parabola B for which

m/e has three times the value corresponding to the parabola A, and B will have a prolongation towards the vertical axis extending to one-third of the normal distance.

For the purposes of Chemical Analysis it is not necessary to use the elaborate apparatus with appliances for measuring the electric and magnetic field. The more elaborate apparatus is only required when we require to know accurately the values of the quantities A and B which occur in the expression for e/m .

For the determination of the masses of the particles producing the different parabolas the measurement of the quantities A and B is unnecessary if we can recognize the particle which produces any particular parabola. For since A and B are the same for all the parabolas, then for any two parabolas we have by the equation on page 180—

$$\frac{(e/m)_1}{(e/m)_2} = \frac{y_1^2/x_1}{y_2^2/x_2}$$

where $(e/m)_1$ $(e/m)_2$ are the values of e/m , for the particles producing the parabolas (1) and (2) respectively, (x_1, y_1) (x_2, y_2) are the co-ordinates of any point on the first and second parabolas respectively.

If the points on the two parabolas have the same values of x so that $x_1 = x_2$ then

$$\frac{(e/m)_1}{(e/m)_2} = \frac{y_1^2}{y_2^2}$$

if the charges are the same

$$\frac{m_2}{m_1} = \frac{y_1^2}{y_2^2}$$

As the line corresponding to the atom of hydrogen occurs on all the plates and can at once be recognized by being the most deflected line on the plate, the value of (e/m) for the particles producing any parabola can be at once, by the aid of

this formula, compared with the value of this quantity for an atom of hydrogen and the masses of the various particles thereby determined.

A convenient instrument for making the necessary measurements is shown in Fig. 14. The plate is inserted in the holder A. The camera is arranged so that the direction in which the rays are deflected by the magnetic force alone (the vertical axis in the preceding figures) is parallel to the longer side of the photographic plate. The deflection due to the electrostatic field is at right angles to this and parallel to the shorter side of the plate. The plate is placed in the holder so that the axis of no electrostatic deflection is parallel to, and that of no magnetic deflection perpendicular to, BB. A needle NN whose point comes close to the plate is placed in the carrier C which can move parallel to BB by sliding along BB, and perpendicular to it by means of the screw S; the position of the carrier is read by two verniers, V_1 and V_2 . There is always a circular patch at the place where the undeflected particles hit the plate: the zero is at the centre of the spot. By putting the needle first at the centre of the spot, then moving the carrier through a certain distance perpendicular to BB by the screw S, and sliding the carrier parallel to BB until the needle comes on the parabolas in turn, the values of y for the different parabolas corresponding to a constant value of x can be measured.

The equation on page 183 enables us to find the ratio of the masses of the particles producing the different parabolas. We can avoid any uncertainty as to the position of the zero by taking two photographs, the electrostatic field remaining the same in the two, while the magnetic field in the first photograph is equal in magnitude but opposite in direction to that in the second. Thus each kind of particle will now give two parabolic arcs, as in Fig. 3, Plate 2, and the distance

between two points AB situated on the same vertical line will be twice the vertical deflection due to either magnetic field. As these arcs are much finer than the central spot, the distance AB can be measured with greater accuracy than either deflection separately.

If, as is very often the case, we can recognize two parabolas as due to atoms, or molecules of known atomic weight, we can eliminate any uncertainty arising from the position of the zero without reversing the magnetic field. For if T_1, T_2, T_3 are the vertical displacements corresponding to particles with charge e and masses m_1, m_2, m_3

$$\frac{T_1}{T_2} = \sqrt{\frac{m_2}{m_1}} \text{ and } \frac{T_1}{T_3} = \sqrt{\frac{m_3}{m_1}};$$

hence
$$\sqrt{\frac{m_3}{m_1}} = \frac{1}{\sqrt{m_1}} + \frac{T_3 - T_1}{T_2 - T_1} \left\{ \frac{1}{\sqrt{m_2}} - \frac{1}{\sqrt{m_1}} \right\}$$

Since $T_3 - T_1$ and $T_2 - T_1$ are independent of the position of the zero, any indeterminateness in that point will not affect the values of m_3 obtained by this equation.

When the values of m_1, m_2, m_3 are so close together that a horizontal line cuts within the limits of the plate the three parabolas corresponding to them, it is better to measure the horizontal rather than the vertical displacements. When we measure the displacements along a horizontal line, y is constant, so that from the equation

$$y^2 = x \cdot \frac{e}{m} \frac{B^2}{A}$$

we get, if x_1, x_2, x_3 are the values of x where the horizontal line cuts the three parabolas,

$$\frac{x_1}{m_1} = \frac{x_2}{m_2} = \frac{x_3}{m_3}$$

or
$$m_3 = m_1 + \frac{(x_3 - x_1)}{x_2 - x_1} (m_2 - m_1).$$

The parabolas intersect the horizontal line so that the intercepts on this line are proportional to the masses of the particles. This gives a very convenient and open scale, but it is evident from an inspection of the photographs that the line will only intersect a few parabolas, and these will correspond to particles with not very different atomic weights. Another disadvantage of this method is that it fails, whereas in the photographs shown in Fig. 2, Plate 1, and Fig. 1, Plate 4, some of the parabolas are very short.

A method which is not open to this objection, and which gives a more open scale than that obtained by measuring the vertical deflections on a plate placed at right angles to the undeflected path of the particles, is to place the plate parallel to this path, and at right angles to the displacement produced by the magnetic force.

We see from the equations on page 20 that if y is the deflection due to the magnet force at a point at a distance x from the place where the electric and magnetic fields stop, z the deflection due to the electric field at the same place.

$$y = \frac{H e}{m v} \left(\frac{l^2}{2} + lx \right) \dots \dots \dots (1)$$

$$z = \frac{X e}{m v^2} \left(\frac{l^2}{2} + lx \right) \dots \dots \dots (2)$$

Thus
$$y^2 = zl \left(\frac{l}{2} + x \right) \frac{e}{m} \frac{H^2}{X}$$

If the photographic plate is placed at right angles to the axis of y , then $y = b$ all over the plate, and the particles will intersect the plate in the curves given by the equation

or
$$b^2 = zl \left(\frac{l}{2} + x \right) \frac{e}{m} \frac{H}{X} \dots \dots \dots (3)$$

$$z \left(\frac{l}{2} + x \right) = \frac{m b^2 X}{e H^2 l}$$

The right-hand side is constant when m/e is constant,

hence all the particles of the same kind will lie on the curve
$$z\left(\frac{l}{2} + x\right) = \text{a constant.}$$

This is a rectangular hyperbola. Thus when the plate is placed in this position, the curves registered by the positive rays will be a series of rectangular hyperbolas and not parabolas as in the usual position of the plate. The asymptotes of these hyperbolas are $z = 0$; $\frac{l}{2} + x = 0$.

To get the complete hyperbolas all values of v would be required, but there are no particles in the positive rays with energy greater than that corresponding to the fall of the particle through the potential difference between the anode and the cathode of the discharge tube; if V is this potential difference, then the maximum value of $\frac{1}{2}mv^2$ is Ve . Hence, from equation (2) there can be no values of z less than those given by the equation

$$z = \frac{Xl}{2V} \left(\frac{l}{2} + x\right). \dots \dots \dots (4)$$

This is the equation to a straight line in the plane of xz . The hyperbolas will only exist on one side of this line. The "heads" of the hyperbolas will lie on this line just as the heads of the parabolas in the other method lie on a vertical line. The intercepts on this line made by the hyperbolas will by equations (3) and (4) be given by the equations

$$\frac{l}{2} + x = \frac{b}{lH} \sqrt{\frac{2V \cdot m}{e}}$$

$$z = \frac{bX}{H} \sqrt{\frac{m}{2Ve}}$$

So that the length of the intercept measured from O, the point whose co-ordinates are $z = 0, x = -\frac{l}{2}$ is equal to

$$\sqrt{\frac{m}{e}} \cdot \frac{b}{Hl} \left\{ 2V + \frac{X^2 l^2}{2V} \right\}^{\frac{1}{2}}.$$

Thus the distances of the heads of the hyperbolas from O are proportional to $m^{\frac{1}{2}}$, hence if we measure these distances we can compare, just as on the other method, the atomic weights corresponding to the various curves. On this method, however, we have a scale proportional to $m^{\frac{1}{2}}$ which in some respects is more convenient than the other scale, which is proportional to $m^{-\frac{1}{2}}$. The new method has the disadvantage that the curves, due to the negatively charged particles, cannot be obtained without a fresh exposure of the plate.

DISCUSSION OF PHOTOGRAPHS

If we exhaust a tube originally filled with air down to the lowest pressure compatible with the production of the positive rays, and take a photograph, we obtain a spectrum which may be called that of the "residual gas." This gas consists mainly of hydrogen and carbonic oxide liberated from the walls of the tube. The spectrum shows the parabolas due to the atoms and molecules of hydrogen, to the atoms of carbon and oxygen, to the molecules of CO and CO₂, and to the atom of mercury, the last is due to the mercury vapour coming from the pump. Unless special precautions are taken these parabolas occur on all the photographs. It is possible, however, by maintaining a constant stream of a pure gas through the tube to reduce the brightness of these lines so much that they are inconspicuous in comparison with those due to the pure gas. An example of that is shown in Fig. 2, Plate II, which represents the photograph obtained when a stream of pure oxygen was kept running through the tube. The only parabolas which are strong enough to be seen in the reproduction are, on the positive side, the one corresponding to the oxygen atom with two charges, that corresponding to this atom with one charge, and that corre-

sponding to the oxygen molecule; on the negative side we have the line corresponding to the oxygen atom with one negative charge. When hydrocarbons are in the tube we find in addition to the parabola corresponding to the carbon atom, those corresponding to the radicles CH, CH₂, CH₃, showing that these can have an independent existence; if the hydrocarbons are complex we get many parabolas corresponding to more complex combinations of carbon and hydrogen atoms. We even find some of these occurring on the side of the photograph corresponding to negative charges. Thus on a photograph taken when the vapour of hexane was in the tube were found negative lines corresponding to C, CH, C₂, and C₃. By comparing the intensities of the lines due to the various radicles in the positive ray spectrum of a hydrocarbon, information might be obtained as to the constitutional formula by which the molecule could best be represented.

One point which is brought into prominence by the study of these photographs is the great number and variety of the carriers of positive electricity in the electric discharge. Some of the photographs show more than thirty different parabolas: many of these correspond to compounds which have not been detected under other conditions. Thus, taking into consideration only those parabolas for which m/e is less than 20, we find in addition to the radicles CH, CH₂, CH₃ already mentioned, parabolas corresponding to $m/e = 17$ indicating in some cases the radicle OH, in others the molecule NH₃, others corresponding to $m/e = 18$, the water molecule, and others corresponding to $m/e = 19$, generally I think due to H₂O. Then, again, we find on the photographs, in some cases, lines due to diatomic molecules of elements which are usually regarded as monatomic, thus occasionally a line due to diatomic mercury $m/e = 400$ is found on the plate. And

though diatomic helium would give a parabola $m/e = 8$, which would be indistinguishable from the very common line due to the oxygen atom with two charges, I have some photographs in which the helium parabola $m/e = 4$ has its head at twice the normal distance from the vertical, indicating in accordance with the argument given on p. 85, that before entering the electric and magnetic fields the atoms producing this parabola had, during the passage through the discharge tube, been the constituents of a diatomic molecule of helium.

EXAMINATION OF THE GASES GIVEN OUT WHEN SOLIDS ARE BOMBARDED BY CATHODE RAYS

The positive rays supply a very convenient method for studying the gases given out when minerals or solids of any kind are bombarded by cathode rays. The apparatus used for this purpose is shown in Fig. 17, p. 34. G is the vessel in which the positive rays are produced. A is a vessel communicating with B by two tubes, one of which BC is a very fine capillary tube, while the upper one is 5 or 6 millimetres in diameter; taps are inserted so that one or both of these tubes may be closed and the vessels A and G isolated from each other. The vessel A contains a curved cathode like those used for Röntgen ray focus tubes, and the cathode rays focus on the platform on which the substance to be bombarded is placed. After the solid under examination has been placed on the platform, the taps between A and B are turned, and A is exhausted by a Gaede pump until the vacuum is low enough to give cathode rays. An electric discharge is then sent through A and the solid on the platform is bombarded. The result of the bombardment is that in a few seconds so much gas, mainly CO_2 and hydrogen, is driven out of the solid that

the pressure gets too high for the cathode rays to be formed. To lower the pressure a tube containing charcoal cooled by liquid air is connected with A, the charcoal absorbs the CO_2 and enough of the hydrogen to keep the vacuum low enough to give cathode rays.

To find what gases are given off by the bombardment, the connection between A and G is cut off while the bombardment is going on, and after the bombardment is completed a photograph of the positive rays is taken before the connection is opened. The taps between A and G are then turned, the gas from A is allowed to stream through G and another photograph is taken; the lines in the second photograph which are not in the first represent the gases which have been liberated from the solid by the cathode rays. Fig. 2, Plate V, and Fig. 2, Plate VII, represent two such photographs, the lower one in Plate V that taken before turning the tap, the upper one after. In the latter, there are the following lines which do not occur in the former: (1) a strong line corresponding to a substance with atomic weight 3; (2) one corresponding to helium, this is generally much fainter than the "3" line; and (3) lines representing neon with one and two charges. The amounts of helium and neon are so small that their lines are often not visible when the discharge in the tube is observed through a spectroscope. This photograph is typical of what is observed when substances such as the metals platinum, palladium, aluminium, copper, zinc, iron, nickel, silver, gold, lead, graphite and a large number of salts are first bombarded with cathode rays. The helium line generally diminishes in brightness after the bombardment has been prolonged for some hours, the "3" line is, however, much more persistent and in some cases, for example, that of KHO, the bombardment may be continued for several weeks without producing any diminution in the brightness of the "3" line.

The presence of mercury in the vessel A decreases the intensity of the "3," hence, we may conclude, I think, that the substance which gives the "3" line combines with mercury vapour when an electric discharge passes through a mixture of the two gases. Another case where the presence of one gas causes the disappearance of the lines due to another, is that of oxygen and mercury vapour. The mercury lines are not seen in the photographs of the positive rays when the gas in the tube is mainly oxygen, although with most gases these are about the strongest lines on the plate. The disappearance of the mercury lines can be accounted for readily by the combination of the mercury vapour with the oxygen.

The fact that the brightness of the helium line diminishes after long bombardment, suggests that helium has been absorbed by, or accumulated on, the substance bombarded by the cathode rays. Both helium and neon are present in the atmosphere, and the positive-ray method is sufficiently sensitive to detect the helium in a cubic centimetre of air at standard temperature and pressure, so that if an appreciable amount of air were dispersed through the solid it would account for the presence of the helium and neon lines. The presence of helium in the air makes it necessary when investigating the gases given off by solids to take precautions against the helium being accidentally introduced into the tube from the atmosphere. It is, for example, necessary to be very careful in the use of charcoal cooled by liquid air, for producing the final vacuum. The cooled charcoal only absorbs a small quantity of the helium in the air, so that this gas is not removed from the vessel by this method. Fig. 3, Plate VII, is a photograph when the air from the discharge tube was exhausted entirely by charcoal; it will be seen that the helium line and the "3" line are both strong. It is

necessary in experiments of this kind to reduce by a mercury pump the pressure to a fraction of a millimetre of mercury before applying the cooled charcoal. We can, however, in experiments, when the helium is liberated by long bombardment, eliminate this source of error, for if the helium and neon come from the air and not from the solid the quantity of those gases in the tube would not depend on the duration of the bombardment. The amount of helium liberated is, however, not appreciable unless the bombardment is prolonged for an hour or so and it increases with the duration of the bombardment. Thus, if the helium comes from air the air must have been absorbed by the substance and liberated from it by the bombardment. To test this point soluble salts, such as LiCl, NaCl, KCl, KI, RbCl, AgNO₃, were dissolved in water, some of them also in alcohol, and then evaporated to dryness, the process being in some cases repeated several times. Even after this treatment they yielded perceptible amounts of helium, the yield was greatest from the potassium salts, especially from KI. To test whether solution and evaporation would get rid of dissolved helium the following experiment was tried. It is well known that when the electric discharge passes from aluminium electrodes through helium the electrodes absorb some of the helium. A piece of aluminium was divided into two portions, one half was made into the electrodes of a vacuum tube filled with helium at the pressure of three or four millimetres of mercury and a current passed through the gas for two days. After this treatment the electrodes were dissolved in hydrochloric acid and the solution evaporated to dryness. The salt thus obtained was then placed in the positive-ray apparatus, bombarded by cathode rays for several hours, and a positive-ray photograph of the gas given off taken: it was found that the helium line was

perceptible though faint. The other piece of aluminium which had not been near helium was then dissolved, evaporated and bombarded and the photograph taken; the intensity of the helium line in this photograph was but little less than in the other: this experiment shows, I think, that solution may be relied upon to remove absorbed gas unless the gas is in some special state which does not occur when the absorption is due to the use of the metal as an electrode.

The aluminium cathode in the tube used to bombard the substances with cathode rays might be suspected as a source of helium. If, however, the helium came from it the rate of liberation would not depend upon the nature of the salt bombarded, nor would it make any difference whether the cathode rays hit the salt or not. As both these conditions have great influence on the liberation of helium we may regard this source as eliminated, a conclusion confirmed by the fact that there was no perceptible diminution in the supply of helium after the cathode had been in almost continual use for several months.

One feature in the liberation of helium from salts is the very considerable variation in the amount of the helium set free by different specimens of the same salt when bombarded under apparently identical conditions, different salts of the same metal, too, show considerable differences with respect to helium production. Thus, I have always obtained more helium from KI than from KCl. These effects, as well as the fact that the rate of production falls off after long bombardment, suggest that the source of the gas is not the whole mass of the salt, but something which may be described as an accidental accompaniment. One possible source is a layer of condensed air over the surface of the salt. We know that when an electric discharge passes through an exhausted vessel a considerable amount of gas comes from

the walls of the vessel unless these have been maintained for some time at a high temperature, and have also been subjected to a prolonged bombardment by cathode rays.

It is certain that any solid which has been exposed to the air gives off when bombarded a considerable quantity of gas, mainly hydrogen and carbon monoxide; the hydrogen is usually ascribed to the water vapour condensed on the surface. We know too little about these layers of condensed gas to say whether or not they would contain the same proportion of helium as the free air, or how the amount of gas on the surface depends on the chemical composition of the salt. It is consistent with this view that if the salt be kept in a vacuum the rate of evolution of helium gradually falls away as the bombardment is prolonged. Another view worthy of consideration is that in the atoms of the ordinary elements, and especially, perhaps, in those of the alkali metals, a process may be at work analogous to that which causes the expulsion of an α particle from the atom of the ordinary radioactive elements; the difference being that in the case of the elements where radioactivity has not been detected, the α particle, i.e. the atom of helium, instead of being projected with the enormous velocity characteristic of radioactive substances, is projected with so little energy that it does not wholly escape from the parent atom. It is loosened, so to speak, by effects which are analogous to those of radioactivity, and is finally detached when the atom is exposed to vigorous bombardment by cathode rays. It would only be a small fraction of the atoms of the element where the helium had been so loosened as to be able to be detached by the effect of cathode rays, and when these atoms are exhausted the supply of helium will cease. The view that helium can be got from a large number of elements raises questions of such a fundamental character that few

will be prepared to accept it unless every other explanation has been shown to be untenable. It would strengthen greatly the proof if we could detect the parts of the atom which remain after the helium had been given off. I have made efforts to do this, but have not obtained decisive results. The difficulties are very considerable. Consider, for example, the case of lithium: if we took the helium away we should get a substance with atomic weight 3; we do find this substance when we bombard lithium salts, but we also find it when we bombard salts which do not contain any lithium. Then take sodium: the residue after the liberation of helium would have the atomic weight $23 - 4 = 19$. This is the atomic weight of fluorine, a substance with such energetic chemical properties that it would enter into chemical combination and so escape detection. Beryllium would seem to be the most promising, for the atomic weight of the residue would be $9 - 4 = 5$, and this would give rise to a new line which could not be confused with any other. Unfortunately, though a great deal of helium is given off by minerals like the beryls which contain beryllium, the beryllium salts which I have tried give out exceptionally small quantities of helium.

ON THE NATURE OF X_3 , THE SUBSTANCE GIVING THE "3" LINE

When salts and minerals are bombarded we find when we analyse by the positive rays the gases given off, a line corresponding to a substance with atomic weight 3 as well as the helium line. In fact the "3" line occurs even more frequently in such cases than the helium line, for it is rare to find it absent after any solid has been bombarded by cathode rays, and it not infrequently occurs when no trace of the helium line can be detected.

Again, though the bombardment of minerals or salts is necessary for the production of helium, it is not so for that of X_3 . Thus, for example, X_3 is well developed without any bombardment by cathode rays when the vapour of phosphonium iodide, $\text{PH}_3 \cdot \text{HI}$ is introduced into the discharge; it is generally seen, though the lines are very faint when ammonia is in the tube. Under some conditions of discharge it was found when the only gas introduced into the tube was hydrogen, though this was no doubt contaminated by gases liberated from the walls of the discharge tube. In this case it seems to be dependent upon some special type of discharge, for it is much more frequently absent than present. On the other hand, when salts and minerals are bombarded it is practically always present; one of the best ways of producing it being to bombard KOH with cathode rays. If X_3 is not a new substance, it must either consist of three hydrogen atoms with one charge and be represented by H_3 , or it must be an atom of carbon with four charges. Of course, as a matter of arithmetic, it might be an atom of beryllium (atomic weight 9) with three charges, or of magnesium (atomic weight 24) with eight, but explanations of this type are ruled out by the conditions of the experiment. Hydrogen and carbon, on the other hand, are always present in the tubes, and so are possible sources of X_3 . The view that X_3 is a carbon atom with four charges must be abandoned for the following reasons.

1. We have seen that a line corresponding to an atom with a multiple charge, is, unless the pressure is exceedingly low, accompanied by certain peculiarities in the line corresponding to that atom with one charge. For example, if there were, as there generally is, a line corresponding to a carbon atom with two charges, the line corresponding to the carbon atom with one charge would be

prolonged until its extremity was only one-half the normal distance from the vertical axis; if there were a line corresponding to a carbon atom with three charges, the ordinary carbon line would be prolonged until its distance from the vertical was only one-third of the normal distance; while a carbon atom with four charges would prolong the ordinary carbon line to within one-quarter of the distance from the axis. Again, the greater the charge the less the intensity, so that a line due to a quadruply charged carbon atom would be accompanied by a stronger line due to a triply charged atom, a still stronger one due to a doubly charged atom, while the normal carbon line would be the strongest of all. Now we do not find any of these characteristics in the case of the X_3 line; the carbon line is not prolonged to within one-quarter of the normal distance, and so far from the line being accompanied by a stronger line due to a doubly charged carbon atom, in many cases when the "3" line is very strong the line due to the doubly charged atom is not strong enough to be detected; indeed, in some cases the "3" line is stronger than the normal carbon line.

Again, since the gas giving the "3" line can be detected in the tube long after the bombardment has ceased, if it were carbon with four charges some gas must be formed by the bombardment which gives, when the discharge passes through it, carbon atoms with four charges. Experiments made with a great variety of carbon compounds, introduced directly into the discharge tube, e. g. CH_4 , CO_2 , CO , C_2H_4 , C_2H_2 , $COCl_2$, CCl_4 , failed to produce this line, so this view of its origin must be abandoned.

There is, on the other hand, strong evidence of this line being due to hydrogen. We have seen that under exceptional conditions it can be obtained by sending the discharge through hydrogen without the liberation of gas by bombardment.

The fact that it is produced so easily from phosphonium iodide is a strong argument in favour of this view. Sal ammoniac, prepared by allowing streams of hydrochloric acid gas and ammonia to combine in a vacuum, was found to give X_3 when bombarded. In this case the possibility of this substance having been absorbed in the salt would seem to be excluded.

If we test its rate of evolution from bombarded salts, before and after they have been dissolved and evaporated again to dryness, we find that, with regard to this effect, salts may be divided into two classes. In one class of salts, which includes KI, Li_2CO_3 , KCl, the output of X_3 after this treatment is much smaller than it was before. In the other class, which includes KOH, LiCl, LiOH, $CaCl_2$, the output after solution is much the same as it was before, and is not appreciably diminished by numerous repetitions of this process. The salts of the first class do not contain hydrogen, while those of the second either contain hydrogen or are very deliquescent, and thus can absorb water from the atmosphere on their way to the bombardment chamber after evaporation. The fact that some salts continue to give supplies of X_3 after repeated solution and evaporation shows, I think, that X_3 can be manufactured from substances of definite chemical composition by bombardment with cathode rays, and the fact that such salts contain hydrogen either as part of their constitution, or in water of crystallization, suggests that X_3 consists of hydrogen and is represented by the formula H_3 . One very remarkable feature is the contrast between the ease with which this gas is obtained by bombardment and the difficulty of getting it when the discharge goes through pure hydrogen. For example, I had a tube containing this gas which, though many photographs were taken, never showed a trace of the "3" line. As soon, however, as a small

piece of mica which was in the tube had been bombarded for a few minutes, the "3" line was developed with great intensity. The reason for this is not evident; it is true that hydrogen is given off by the bombardment, but there was in the preceding case plenty of hydrogen in the tube before the bombardment began, so that, unless the hydrogen adhering to the mica and given out on bombardment is in a peculiar state, this will not account for it. I have tried to find a connexion between the rate of evolution and the presence of trivalent elements in the bombarded solid, but have not succeeded in finding one. It is quite certain that the gas is freely given off by KOH, even when considerable trouble is taken to purify the salt, and this substance does not contain any trivalent element. A compound containing a trivalent element might have been expected to contain a group of three hydrogen atoms and thus facilitate the appearance of H_3 . The substance which gives rise to the "3" line has considerable permanence. The gas liberated by the bombardment can be kept for days before being used in the discharge tube, and will still, after this interval, give rise to the "3" line. Again, when once the "3" line has been obtained, the tube continues to give traces of the line after the active gas has been pumped out and no fresh supply of this gas has been introduced; the "3" gas must, I think, be absorbed by the electrodes or condensed on the walls of the tube, with repeated exhaustions it gets fainter and fainter and finally disappears.

The presence of mercury vapour in the discharge tubes diminishes to a very great extent the brightness of the "3" line. This suggests that the substance giving rise to this line combines under the influence of the electric discharge with mercury vapour. The evidence is not quite conclusive, as at very low pressures the presence of mercury vapour has a

considerable effect on the character of the discharge, and this may have an effect upon the intensity of the line.

The substance giving rise to the "3" line, if mixed with oxygen, gradually disappears if the mixture is exposed to strong sunlight, or if strong sparks are sent through the mixture. As X_3 is always mixed with a considerable quantity of hydrogen, a vigorous explosion takes place when the spark passes through the mixture containing oxygen. I found, too, that if X_3 was placed in a quartz tube containing copper oxide it disappeared when the tube was raised to a red heat.

The fact that sparking with oxygen, or heating with copper oxide, the two most efficient ways of removing hydrogen, destroys X_3 , makes the separation of this substance from the great excess of hydrogen which always accompanies it, a matter of very considerable difficulty. The most effective way I know of increasing the percentage of X_3 , is to first take out any oxygen and then to put the mixture into a vessel to which a palladium tube is attached; when the palladium is heated to redness the hydrogen diffuses through it much more rapidly than the X_3 , though some of this gas can get through the palladium. The result is that the gas left behind in the vessel contains a much greater proportion of X_3 than it did before. The preponderance of hydrogen in the original mixture is, however, so great that even by this method I have not been able to prepare any sample in which the hydrogen was not greatly in excess.

Many attempts have been made to obtain spectroscopic evidence of X_3 by putting the mixture containing it in a quartz tube with tin foil electrodes placed outside the tube. The spectrum obtained when the discharge passed through the tube was photographed, but no lines which could be ascribed to X_3 were detected. The first and second spectra

of hydrogen were bright, and in spite of efforts to get rid of mercury vapour the mercury lines were visible. Bombardment by cathode rays is not the only method of obtaining X_3 . I heated by an electric current a fine tantalum wire until it fused, and found that a considerable amount of X_3 was given off. Some time ago I found that when the discharge from a Wehnelt cathode was sent through an exhausted tube X_3 was liberated; later I found that it is not necessary to send the discharge through the tube, the heating of the cathode is sufficient to liberate the gas. Again, when hydrogen, or even air, which has not been specially purified from hydrogen, is exposed to α rays by streaming past a very thin-walled tube containing radium emanation, the gas when examined by the positive rays is found to contain X_3 . Duane and Wendt ("Phys. Rev." 10, p. 116, 1917) have shown by a study of chemical reactions that when hydrogen is exposed to α rays some modification of it is produced whose properties differ from those of normal hydrogen.

Summing up the results, we see that X_3 can be obtained by passing the discharge through gases such as phosphonium iodide, through hydrogen under special conditions of discharge, through hydrogen acted on by α particles; that when it is obtained by bombarding a salt a continuous supply can be obtained when the salt contains hydrogen, while from salts which do not contain hydrogen the supply is soon exhausted. And again, that under certain conditions, such as exposure to bright light or by vigorous sparking, X_3 combines with oxygen, and that it is removed by copper oxide at a red heat. All these results seem to point to the conclusion that X_3 is H_3 triatomic hydrogen. At the same time I do not feel certain that in some cases the "3" line may not arise from another source. My grounds for this view are: (1) the yield of X_3 is exceptionally large from

certain minerals; this is what would happen if X_3 were a permanent gas absorbed by the mineral; (2) when these minerals are bombarded the "3" line shows some characteristics which are not generally present, e.g. the parabolas are very long, sharp and of very uniform intensity. In the majority of cases the "3" line is rather shorter than, say, the other hydrogen lines, and the intensity is apt to vary along the parabola.

It is interesting to find that Fabry from the measurements of the broadening of the "nebulium" line due to thermal agitation, came to the conclusion that the source of this line is an element with atomic weight 3—

THE ORIGIN OF THE LINE $m/e=3.5$

When examining by the aid of the positive rays the gases given out when a specimen of fluorspar from Ivigtut in Greenland was bombarded with cathode rays, I found in addition to a very strong helium line and a fairly strong "3" line, a line between the two corresponding to an atomic weight of 3.5. This fluorspar, to which attention was first called by Thomsen ("Zeits. f. Phys. Chem.," 25, p. 112), possesses very remarkable properties, it gives off when heated very large quantities of helium, and when thrown on a heated plate shines with a bright phosphorescent light. Some other varieties of fluorspar possess this property, but none, of those I have tried, to the same extent. I have found the 3.5 line when some other specimens of fluorspar are bombarded; it is not, however, produced by every kind of fluorspar. I have also found the line when some zircons were bombarded, and occasionally in air after exposure to α rays. After my attention had been called to it in this way I examined my collection of plates to see if any traces of it could be found in the positive-ray photographs of a very large number of

substances. I found that the line could be detected on several plates, though it was so faint that it would escape detection unless attention were specially directed to it. The line is remarkable for the extent to which it is accompanied by secondaries, and these secondaries are not, as is usual, confined to well-defined lines running up to a definite point on the parabola, but spread out like a fan, from one end of the parabola to the other. Another peculiarity of this line is that it is a short line with the head of the parabola much further away from the vertical than the heads of the other parabolas. Thus the maximum energy possessed by the particle giving this line is much less than that possessed by other atoms or molecules in the positive rays. This is what we might expect, for the very strong secondaries show that the 3.5 particle very easily loses its charge and so is not likely to retain it during the whole of its passage through the dark space, and therefore cannot acquire the energy due to the cathode fall of potential. A photograph showing this line is reproduced in Fig. 3, Plate VIII.

It is difficult to account for the line by any known substances. A lithium atom with two charges would give a line in the same position, but the occurrence of the line seems to have no relation to the presence or absence of lithium.

An atom of nitrogen with four charges would give the 3.5 line. The objections to this explanation are :

That it would involve a prolongation of the nitrogen line towards the axis, so that the head of this line would be only one quarter of the normal distance from the vertical ; the nitrogen atom line is often prolonged to within one half of this distance, and we find, as we should expect, that when this prolongation occurs the line 7, corresponding to an atom of nitrogen with two charges, is found on the photographic plate. When, however, the 3.5 line is found as well as the 7

there is no increase in the prolongation of the 14 line, nor is the line 14/3 corresponding to nitrogen with three charges to be found on the plates.

Again, though nitrogen is, unless special precautions are taken, nearly always present in the tube, the presence of the line 3·5 is quite exceptional and does not seem to be connected in any way with the amount of nitrogen in the tube.

The most natural explanation of this line is that it is due to a new element, and the only reason against accepting this explanation is that the atomic weight is not a whole number. There does not at present seem much hope of obtaining sufficient quantities of this substance from known sources to give much chance of isolation. The quantity given out even by the Ivigtut fluorspar is small compared with the amount of helium given out by those minerals which yield supplies sufficient for its isolation. Apart from a new element the only explanation I can think of which is not flatly contradicted by the evidence on the photographs is that it is due to a doubly charged compound of X_3 and He; both these gases are present whenever the 3·5 line is visible, and the 3·5 substance is got by bombarding a mineral in which both helium and hydrogen are present. The complex with one charge would, if it occurred, produce a line coinciding with that due to the nitrogen atom with two charges. Such a line always accompanies the 3·5 line. The existence of X_3 He with two charges ought to prolong the line 7, due to the singly charged complex. I have never observed any such prolongation of this line, but as the line is always a faint one this is not quite conclusive. It is in favour of the view that "3·5" is a compound of He and H_3 that the space between the 3·5 lines and both the H_3 and the He lines is filled with faint luminosity, indicating that the 3·5 substance while passing through the electric fields dissociates into He and H_3 .

There are in addition to the 3.5 line, some other lines corresponding to smaller atomic weights. There are on several plates a line for which $m/e = 1.6$, another for which it is equal to 2.4. These values are independent of the conditions of the discharge. There are others, such as those described on page 68, which are affected by such things as the pressure in the tube, the length of the electric and magnetic fields, and which are either envelopes (see p. 64), or due to unstable complexes. The lines 1.6 and 2.45 do not seem to be dependent, like the other lines, on the presence of gases liberated by the bombardment of minerals. They occur when, as far as is known, there is nothing but the ordinary residual gases in the tube, and they occur most readily when the lines due to the atom or molecule of hydrogen are very prominent. They are, I think, most probably due to complexes of hydrogen atoms with multiple charges. H_3 with three and two charges respectively would give lines in approximately the right position, though if this were the origin of the lines we should expect to find a line corresponding to H_2 with one charge. Figs. 1 and 2, Plate VIII, show a line for which $m/e = 5$; it is, however, of rare occurrence. The lines 1.6 and 2.45 are in nearly every case exceedingly faint, so that the values of m/e are difficult to determine accurately and cannot be relied upon to much less than ten per cent. They are sometimes found on the negative as well as the positive side of the photograph. There is always a considerable amount of luminosity in the space between these lines and those due to the atom and molecule of hydrogen, indicating, I think, that the substance giving these lines is disintegrating into atoms and molecules of hydrogen. It would thus appear that hydrogen has considerable powers of polymerization, forming complexes like H_3 and H_2 . These polymers are formed most readily when the hydrogen is absorbed by a solid or con-

densed on its surface. Of these polymers the evidence from positive rays shows that H_3 is by far the most stable.

The gases liberated when the surfaces of solids are bombarded by cathode rays furnish a very direct proof that the surfaces of these solids and the walls of the tube itself are liable to be coated with layers of gas. These layers play an important part in positive ray work at very low pressures, both in the methods which have to be adopted to succeed in obtaining these pressures and in the interpretation of the results when the positive ray method is used to analyse a gas. The amount of gas which adheres to solid surfaces or is diffused throughout their volumes is exceedingly large, and its removal is a matter of great difficulty. This is not surprising, for to separate a molecule from the surface of a solid or liquid requires the expenditure of a considerable amount of energy which we can estimate without difficulty if we know the latent heat of evaporation of the substance. Thus from the latent heat of steam we find that the work required to separate a molecule of water from a water surface is that corresponding to the fall of the atomic charge of electricity through about half a volt. The tendency to evaporate diminishes very rapidly as this work increases. Thus if it took twice as much energy to remove a water molecule from a glass surface as it does from a water one, the vapour pressure of water vapour over a film of water one molecule thick on glass at 273°C would be about that over a free water surface at 0°C . So that if the glass were heated to 273°C the water films would only evaporate at about the rate ice at 0°C would evaporate in a vacuum at that temperature. If the removal of a molecule required 1.5 volts we should have to heat the surface to 546°C to attain this rate of evaporation. So that we see that for quite moderate amounts of adhesion the film may be so firmly held that it would be practically impossible to liberate it by

heating the glass to any temperature below its melting point.

The work required to remove a molecule with a finite electrical moment (see page 130)—a polar molecule—will be greater than that required to remove a non-polar molecule. Thus since the molecule of H_2O is polar, while those of CO , CO_2 , N_2 are not, we should expect that layers of these gases would be removed much more easily than the water molecules; this is in accordance with experience. The usual experience when an exhausted bulb is heated to a certain temperature is that at first a considerable amount of gas is liberated and the pressure rises, then the rate of liberation of gas slows down and after a time becomes imperceptible. Though no gas comes off at this temperature, if the temperature is raised a fresh supply of gas is liberated, this after a time gives out, and the tube can remain at a constant pressure at the higher temperature. On increasing the temperature again there will be a fresh outburst of gas, and so on; this process goes on certainly up to any temperature which the glass can stand without melting. These considerations make us suspect that it is not possible by heat treatment alone to free the walls of the discharge tube entirely from gas. This is confirmed by the fact that when a solid from which all the gas that can be abstracted by heat treatment has been taken is bombarded by cathode rays, a plentiful supply of gas is given out. The gases which survive the heat treatment, and come off under the bombardment of the cathode rays, i. e. those which are especially firmly held by the glass, contain a large percentage of hydrogen. This is what we should expect on the view that the hydrogen on the glass is in the atomic and not the molecular condition, and that the uncharged atom of hydrogen consists of a central positive charge and a single electron: as there are in this atom two charges, one positive and the

other negative, separated by a distance equal to the radius of the atom, the atom will have a considerable electrical moment—it will be very polar—and therefore will be difficult to separate from glass. The work required to remove an atom in the layer next the glass will be far greater than that required to remove an atom in the layers piled on the top of this layer; so that it seems probable that after heat treatment the solids will be left with a single layer of hydrogen atom spread over the surface. To remove this the surface must be bombarded with cathode or positive rays. Mr. Langmuir, who has made many interesting investigations on the layers of gases condensed on solids, gives reasons for thinking that in the layer next the solid the gaseous atoms or molecules are packed as closely as possible together, and that the number per sq. cm. of surface may amount to 10^{15} . To remove this number by cathode rays, assuming that each atom requires one cathode ray particle for its removal, would involve the reception by each square centimetre of surface of about 4.8×10^5 electrostatic units of electricity.

The existence of a highly compressed layer of hydrogen atoms over the surface of solids would explain the very interesting fact that H_2 is produced so much more readily by bombarding solids than in any other way, for on the surface of these solids we have the atoms in an ideal condition for combination, packed so close together that they are almost in contact, and at the same time ionized and liberated by the action of cathode rays.

Though we cannot expect to get rid of layers of hydrogen atoms by heat treatment we may expect to be able to do so by long-continued bombardment with cathode rays; the maintenance of the vacuum in a Coolidge tube in constant use is a proof that this is the case. Though we ought in this way to be able to eliminate the hydrogen from the walls of

the tube, yet I have never yet been able to eliminate the lines corresponding to the atom and molecule of hydrogen from the positive ray photographs. This is usually ascribed to the hydrocarbon vapours given off by wax used to join up the glass bulb to the metal parts of the apparatus or to the grease used to lubricate the taps. No doubt each of these is a source of vapours containing hydrogen, but I am not satisfied that it is the only source. I have replaced the wax joint by one in which a layer of copper deposited on the glass was soldered to the metal, and liquid air traps were placed between all the taps and the bulb: even with these precautions the hydrogen lines were quite bright on the photographs. Another interesting thing about these lines is that even when a bulb has been running for a long time so that its walls have had a long exposure to cathode rays, the introduction of a little mercury vapour produces a remarkable increase in the brightness of the hydrogen lines; some of this is due to an increase in the current, but this is only part of the reason, for the increase in the hydrogen lines is much greater than in the other lines. I am inclined to think that not only can a hydrogen atom cling to a mercury surface, but that it can also cling to an atom of mercury vapour. The union of the two need not necessarily be of the type of the ordinary valency compounds, where there is a transference of electrons from one atom in the molecule to another. The hydrogen atom may be held to the molecule, in the same way as it is against the mercury surface, *i. e.* by the forces between the electrostatic doublet formed by the hydrogen atom and the electrons in the mercury atom. Compounds of this type where there is no transference of electrons from one atom to another would have properties quite different from those possessed by a compound represented by the same chemical formula, but between whose atoms a redistribution of electrons had occurred.

Thus consider the case of the combination of an atom of chlorine and an atom of hydrogen: if there is no transference of electrons we have a neutral chlorine atom with seven electrons in its outer shell, attached to a neutral hydrogen atom; the chlorine atom can receive an additional electron without its electrons becoming unstable, and its attraction for the hydrogen atom will be increased thereby, thus the molecule of this compound can receive a negative charge. Again, if the chlorine atom instead of gaining an electron lost one or more its attraction for the hydrogen atom would increase, and thus this molecule could receive a multiple charge as readily as an atom of chlorine itself. Let us now consider the union of the same atoms when an electron has gone from the hydrogen atom to the chlorine, making up the number of electrons in the outer layer of its atom to eight. The chlorine atom as a whole has got a negative charge equal to unity, while the hydrogen atom has a unit positive charge. The chlorine atom having eight electrons in its outer layer cannot receive another electron, so that the molecule will not get negatively electrified, while if the chlorine atom were to lose two electrons it would become positively charged and repel the positively charged hydrogen atom. Thus the molecule would break up—so that this type of molecule, unlike the former, could not receive a multiple charge. The work required to dissociate the second type of molecule might be expected to be much greater than that required for the first type, so that the second type would be much more stable than the first: compounds of the first type might form an intermediate stage between the valency compound and the separate atoms of which it is composed.

THE LINES DUE TO NEON

Sir James Dewar was kind enough to supply me with samples of the gases obtained from the residues of liquid air; when the treatment of these residues had been such as to retain the lighter constituents of the atmosphere, the photographs showed a line corresponding to helium, strong lines corresponding to neon with both single and double charges; and, in addition, a line corresponding to an element with an atomic weight 22, and also a line corresponding to this element with a double charge. A molecule of CO_2 with a double charge would give the line 22, but this cannot be its origin, as the CO_2 can be removed from the gas without diminishing the intensity of the line. This line is much fainter than the neon line, so that in the atmosphere the quantity of the gas which is the source of the line must be small compared with the quantity of neon.

The compound NeH_2 would have the required mass, but the fact that the origin of the line can carry a double charge, as is shown by the presence of the line $m/e = 11$, is strong evidence that it is due to an element and not a compound. The atoms of the elements other than hydrogen all occur with double charges, and though the occurrence of a molecule of a compound with a double charge is not unknown, it is very exceptional.

Mr. Aston made many attempts at the Cavendish Laboratory to separate the new gas from neon, which has an atomic weight of 22. The first method he tried was to fractionate a mixture of the two gases by means of their absorption by coco-nut charcoal cooled by liquid air, the absorption of the heavier gas being expected to be greater than that of the lighter.

No appreciable effect, however, was produced by this fractionation ; indeed, from an investigation by Lindemann and Aston, "Phil. Mag." [6], 37, p. 523, 1919, it would seem that the effect which was to be anticipated was smaller than could have been detected by Aston's experiments. Another method used by Aston was to allow the mixture to diffuse through a porous substance, like the stem of a clay tobacco-pipe, when the lighter constituent would get through a little more rapidly than the heavier one ; he designed an automatic apparatus in which the diffusion went on uninterruptedly, but no decisive results were obtained.

Mr. Aston has recently attacked the problem by quite a different method, based on the following considerations :—

If the neon in the atmosphere contains two different constituents, then the atomic weight 20.2, determined by the measurement of the density of the gas, will not be the atomic weight of either constituent, but a mean value depending on the proportion in which the constituents are present. The measurement of the positive-ray photographs enable us to determine the atomic weight of the substance giving rise to any particular line, and if these measurements can be made with such accuracy as to enable us to say that neither of the lines has an atomic weight which corresponds to that of the atmospheric neon, this would prove that the neon in the atmosphere is a mixture. The evidence would be still stronger if the atomic weight of the mixture 20.2 agreed with the mean of the atomic weights of the constituents, the proportion between the constituents being determined from the relative intensities of the lines on the photographic plate.

Mr. Aston determined, by the focus method described on page 36, the atomic weights of the substances producing the neon line, and its companion the line for which $m/e = 22$.

The focus method is an interpolation method where the atomic weight of a substance producing a line is determined by comparing the position of the line relative to lines due to substances of known atomic weight. The way in which this is done will be understood by considering the following example. When the gas in the discharge tube is the residual gas left after the tube has been exhausted, the positive-ray spectrum shows a group of five lines due to C(12), CH(13), CH₂ or N(14), CH₃(15), CH₄ or O(16): those form the five bands α , β , γ , δ , ϵ . The edges of the bands are well defined, and the distance between two of the edges can be measured with a high degree of accuracy. The measurements showed that for this group the distances between corresponding edges of adjacent bands was constant throughout the group. As the adjacent bands are due to particles whose atomic weights differ by unity, we may conclude that in this part of the photograph the relation between the position of the edge of the band and the atomic weight is a linear one. When neon is put into the tube, there are in addition to the five bands already mentioned two new ones a , b . The edge of a is very accurately two units away from the corresponding edge of the band C(12), while the edge of b is one unit away from the same edge; hence we conclude that a is due to a substance for which $m/e = 10$, and b to one for which $m/e = 11$. The lines a , b are the lines corresponding to doubly charged particles, the singly charged particles giving the neon line and its companion. Hence we conclude that the atomic weight of the particles are respectively 20 and 22. Mr. Aston regards his measurements as being accurate to a small fraction of one per cent. and that a particle with the atomic weight 20.2, that usually assigned to neon, could not possibly be the origin of either of these lines. Thus on this view

the neon of the atmosphere is a mixture of two substances, one having an atomic weight of 20 and the other of 22; the mixture containing nine parts of the former to one of the latter, so that its density is 20.2. Those proportions are not incompatible with the intensity of their lines in the positive-ray photographs. Since no difference either in the spectrum or in the chemical properties can be detected between these substances they are called isotopes. Examples of such isotopes had previously been observed in the products of radioactive transformations, such as radio-lead and thorium, which have different atomic weights, and which are supposed to be inseparable from each other by any chemical process.

As far as the evidence from the positive rays goes, the proof that the substance 22 is a separate element and not a hydride of 20 is not absolutely conclusive. This evidence is based on the occurrence of the line II as well as of 22, showing that the particle producing the line can carry a double charge. The occurrence of a *molecule* with a double charge is not unknown, though it is exceedingly rare, while with the exception of hydrogen most atoms can carry a double charge. The fact that the atomic weight of ordinary neon is not affected by sending powerful electrical discharges through it is against the view that 22 is a hydride, for neon does not combine under ordinary circumstances with hydrogen, and if as might be expected the discharge dissociated the hydride into Ne and H₂ the hydride would not be reformed and the density of the "neon" would approach 20.

On the view that the atoms of the different chemical elements are built up of the same constituents, say atoms of hydrogen and helium, the atom of 22 would be that of 20 with the addition of a molecule of hydrogen, in this sense it might be called a compound of 20 and hydrogen, but whereas

in ordinary chemical compounds the atoms of the different elements are separated by distances comparable with 10^{-8} cm. in "22" the 20 and H_2 are only separated by a very minute fraction of that distance.

DETERMINATION OF ATOMIC WEIGHTS BY THE POSITIVE RAYS

In addition to its use for the detection of new substances the method of positive rays furnishes, when it can be used, a method for determining the atomic weight of the elements which possesses great advantages over all other methods, inasmuch as the presence of impurities does not produce any effect on the result. We have seen (see p. 183) that by the measurement of the positive-ray parabolas we can compare the atomic weight of the particles producing the lines. When three lines are near together, then, as was shown on p. 185, we can find with great accuracy the atomic weight of the carriers of one of the lines in terms of the atomic weights of the carriers of the other two. Thus, for example, the lines due to carbon, nitrogen and oxygen come near together, and assuming the weights of carbon and oxygen we can deduce that of nitrogen. A few years ago I measured a considerable number of plates with this object, and found that the atomic weight of nitrogen was 14 to an accuracy of one part in a thousand. This is a point of some interest, because nitrogen and beryllium are, among the elements with atomic weights less than forty, the only exceptions to the rule that the remainder when the atomic weight is divided by 4 is either nothing or 3, and it was important to prove that 14 was the atomic weight of a single element and not the mean of the atomic weight of two elements which could not be separated

by chemical methods. The result of the positive-ray determination shows that nitrogen is a genuine exception to the law. I have made similar determinations for beryllium; the beryllium line is very difficult to obtain on positive-ray photographs, but by bombarding some beryls with cathode rays I obtained a faint line between the line 8, corresponding to oxygen with two charges, and the carbon line 12; the line was not sharp enough to obtain very accurate measurements, but the atomic weight was certainly nearer to 9 than to any other integer. It would seem from this that beryllium, like nitrogen, is a genuine exception to the law just quoted, beryllium giving a remainder 1 and nitrogen a remainder 2.

Mr. Aston has applied his focus method to determine the atomic weight of most of the elements which can be obtained in the gaseous state, linking the atomic weight of one element with that of another by the method outlined on page 214. The results he obtains differ in some cases very materially from those hitherto accepted, the atomic weights ($O = 16$) being much nearer to integral values than the earlier values. This is especially marked in the case of chlorine. With chlorine in the tube no line was found in the position corresponding to 35.4, the accepted value, but lines were found corresponding to atomic weights 35, 36, 37, 38 (Plate IX).

On Mr. Aston's view 35 is the atomic weight of one form of chlorine, 36 the hydride of this form HCl , while 37 is not H_2Cl but an isotope of chlorine of atomic weight 37; the ordinary chlorine whose atomic weight has been determined by the chemists he regards as a mixture of two isotopes, one having the atomic weight 35, and the other the atomic weight 37. The ground for supposing that 37 is an isotope, and not the hydride ClH_2 , is that the line 18.5, which corresponds to a particle with an atomic weight 37 with a double charge, is

found on the plate, and as a general rule it is atoms and not molecules which carry a double charge. Though this rule is generally true, there are exceptions to it, and the occurrence of the double charge cannot be regarded as conclusive evidence of the atomic character of the origin of the line. As a matter of fact, the line 18, which would correspond to the hydride ClH with a double charge, is found on the plate, but as this might also arise from water vapour H_2O we cannot draw any conclusion as to whether 36 can carry a double charge. Again Mr. Aston has found that lines corresponding to atomic weights 35 and 37 are found on the negative side of the plate. This again is a presumption that these lines correspond to atoms and not to molecules, as atoms occur more frequently than molecules with a negative charge. The fact that no line occurs on the positive-ray photographs corresponding to an atomic weight 35.46 is a very interesting and important fact, for the atomic weight of chlorine was supposed to be known with an accuracy of one part in a thousand by determinations separated by long intervals of time, and therefore made with samples of chlorine, presumably obtained from very different sources and localities; these determinations were made by many different methods and included comparisons of the density of gaseous chlorine with that of a standard gas. The case of chlorine is exceptionally interesting, because it seems to be the one which promises to give the best chance of success in demonstrating by direct methods the existence of isotopes. This is due, firstly, to the energetic properties of chlorine, and, secondly, to the fact that each of the constituents is present in comparable proportions; for if the atomic weight 35.5 is due to a mixture of 35 and 37, ordinary chlorine must contain about 70 per cent. of the lighter and 30 of the heavier element.

It is easy to exaggerate the similarity of isotopes and the

theoretical difficulties in the way of their separation. Many of the chemical effects due to an element, and especially to one in the gaseous state, must be influenced by its mass, the velocity of chemical reactions is a case in point. Let us, for example, suppose that we have a mixture of two gaseous isotopes of HCl of molecular weights 36 and 38 flowing through a tube lined with some substance which combines with both of them. The average velocity of the molecules of the lighter constituent would be greater than that of the heavier one, the number of collisions made by the molecules of the lighter constituents with the walls of the tube in a given time would for the same number of molecules be greater than for those made by the heavier ones. The absorption of the lighter constituents will be greater than that of the heavier one, so that after passing through the tube the proportion of the heavier constituent will increase and the composition of the mixture will be changed. A simple calculation will show that if a litre of the gas is reduced by absorption to about 1 c.c. the density of the residue will be greater by about .2 per cent than that of the original gas, to produce an increase of density of 1% the absorption would have to go on until the litre was reduced to about 10^{-12} c.c. A change of .2 per cent in the density could be determined with certainty. This experiment would be an easier one than the attempt to separate the two constituents of neon by diffusion through porous tubes.

I made myself, a few years ago, a number of experiments with the object of seeing whether I could get any evidence that "ordinary" chlorine is a mixture of different substances, as this seems the most natural explanation of the anomaly in its atomic weight. The resolution with the apparatus I used was not sufficient to enable me to find the atomic weight to an accuracy of more than one cent., so it was not possible to settle

the question by the measurement of the atomic weight of the element giving the chlorine line. I observed, however, in the neighbourhood of this line a number of other lines; I attributed these lines, however, to hydrides, and not to isotopes, because though they were fairly strong on the side of the photograph corresponding to positively charged particles on the side corresponding to the negatively charged particles, I could only see one line, and that a very strong one, on the negative side. If the difference of density is due to the presence of an isotope of atomic weight 37, the amount of this isotope must be about one-third of that of the lighter constituent, and on my photographs the intensity of the main negative line was so great that I thought a line with one-third of this intensity could not escape detection. I found too large differences in the relative intensities of the lines due to particles with positive charges; this is not what we should expect if they were due to isotopes possessing identical chemical properties and present in invariable proportions.

Mr. Aston's experiments show conclusively that one of the constituents of Cl has the atomic weight 35; direct evidence that the substance responsible for the line 37 is an isotope of this constituent is very desirable.

In addition to his experiments on chlorine Mr. Aston has examined the atomic weights of most of the elements which can conveniently be studied by the positive-ray method; these include H, He, C, N, O, Ne, Cl, A, Kr, Xe, Hg. He concludes from these experiments that the atoms of the first five elements are all of one kind, while the atoms of the others are of two or more different kinds, the atomic weights of the different atoms differing in most cases by two units, though in the case of Krypton there is one that only differs by one unit from its nearest neighbour. The results of the experiments are given in the following table :—

Element.	Accepted atomic weight.	Minimum number of isotopes.	Atomic weight of isotopes in order of intensity.
H	1'008	1	1'008
He	3'99	1	4
B	10'9	2	11, 10
C	12'00	1	12
N	14'00	1	14
O	16'00	1	16
F	19'00	1	19
Ne	20'2	2	20, 22 (21)
Si	28'3	2	28, 29, (30)
P	31'04	1	31
S	32'06	1	32
Cl	35'46	2	35, 37, (39)
Ar	39'9	(2)	40 (36)
As	74'96	1	75
Br	79'92	2	79, 81
Kr	82'92	6	84, 86, 82, 83, 80, 78
I	126'92	1	127
Xe	130'2	5	(129, 132, 131, 134, 136)
Hg	200'6	(5)	(197-200, 202, 204).

The figures enclosed in brackets are provisional.

It will be noticed that within the accuracy of the experiments, which was estimated to be about one part in a thousand, all the atomic weights determined by the positive ray method are integers, a most interesting and important result, involving as it does the conclusion that measurements which were regarded as the most trustworthy in the whole range of chemistry have given results which are only the roughest approximation to the truth.

Lithium, atomic weight 7, has been shown by G. P. Thomson and Aston (*Nature*, Feb. 24, 1921) to have an element with atomic weight 6 as a companion, while Dempster

has shown that magnesium atomic weight 24 has elements 26, 29 as companions (Proc. Nat. Ac., Wash, 7, p. 45, 1921). The relative intensities of the lithium lines 6 and 7 have been found both by Thomson and Dempster to be very variable.

The method of analysing a gas by superposed magnetic and electric fields can be applied to cases other than those in which the ions are positive rays streaming through a hole in the cathode. It can be applied, for example, to investigate the nature of the ions in the electric arc, in the positive column of a discharge through a gas at low pressure, the ions produced in flames, and so on. In these cases the ions have not in general sufficient energy to affect a photographic plate, so that it is necessary to accelerate them before they reach the plate. To do this the ions are produced in a vessel A, which is connected by a very narrow channel with another vessel B, in which a high vacuum is maintained. The gases from A rush through the channel into B, when they at once pass through two parallel pieces of wire gauze, between which there is a potential difference of several thousand volts obtained by connecting them with the poles of a small Wimshurst electrical machine, a spark a few millimetres long passing between the poles. The field between the gauzes accelerates the ions of one sign and gives them energy enough to affect the photographic plate which they reach after passing through the usual electric and magnetic fields.

The method of positive rays enables us to apply searching tests to theories of the constitution of the atom and the structure of molecules. Thus for example on one theory the atoms of the elements are made up of electrons and one positive charge, the positive charge being at the centre and the electrons distributed around it. The negative electricity on the electrons is equal in magnitude to the positive electricity on the positive charge. The atoms of the different

elements contain different numbers of electrons, thus the atom of hydrogen is supposed to possess one electron, the helium atom two, the lithium atom three, and so on, the number of electrons in the atom being equal to the atomic number of the element.

The arrangement of the electrons in the atom is determined by the condition that each electron is in equilibrium under the forces acting upon it. These forces are the mutual repulsion of the electrons and the force exerted by the positive charge. The latter force, though following the inverse square law at distances which are either very large or very small compared with the radius of the atom, is supposed at distances which are comparable with this radius to follow a more complicated law and to change at certain distances from attraction to repulsion, and at others from repulsion to attraction as the distance diminishes. At the places where the force changes from attraction to repulsion a single electron would be in stable equilibrium under the action of the positive charge.

The most obvious arrangement for a number of electrons would be a symmetrical distribution over the surface of a sphere with its centre at the positive charge. If there were a considerable number of electrons this arrangement would bring them near together, and, in consequence of their mutual repulsions, there would be a tendency for the configuration to become unstable; this tendency would increase rapidly as the number of electrons increased. Whatever be the law of force between the positive charge and an electron, there will be a limit to n , the number of electrons which can be in stable equilibrium on the surface of a sphere with a positive charge ne at the centre, there will thus be a limit to the number of electrons which can form the outer layer of an atom. If the law of force between a positive charge

and an electron is $\frac{a}{r^2} - \frac{b}{r^3}$, it can be proved that eight is the maximum number of electrons which can be in stable equilibrium on the surface of the outer layer. Thus if an atom contained nine electrons, they could not all be on the surface of a sphere, eight would be on such a surface and one outside. Similarly, if there were ten electrons, eight would be on the surface of a sphere and two outside; with eleven electrons there would be three outside, and so on; with sixteen electrons there would be eight outside—this is the maximum that can be on one layer, so that a seventeen electron atom would have two layers of eight electrons each and one electron outside, the number outside being the same as the nine or the one electron atom. Thus the one, nine, and seventeen electron atoms have this in common, that the outermost layer contains one electron; similarly each of the two, ten, and eighteen electron atoms have two electrons outside; the three, eleven, and nineteen electron atoms will each have three electrons outside, and so on. Thus, as the number of electrons in the atoms of the element increases, i. e. as the atomic weight increases, the number of electrons in the outer layer will recur periodically, and any property which depends on this number, such as the valency of the element, will recur periodically also. Thus we get in this way an explanation of Mendeleef's Periodic Law, the elements in the same group having the same number of electrons in the outer layer.

Thus the atoms of the group

H, Li, Na, K,

are supposed to have one electron in the outer layer; those in the groups

Be, Mg, Ca,
Bo, Al,

C,	Si,	
N,	P,	
O,	S,	Sc,
Fl,	Cl,	Br,
Ne,	Arg,	

two, three, four, five, six, seven and eight respectively.

Let us consider the bearing of this on the existence of multiply charged positive ions, i.e. ions which have lost more than one electron. Those electrons will have come from the outer layer, as the electrons in this layer are much more easily detached from the atom than those in the inner layers; thus we should not expect to find atoms carrying multiple charges unless there were more electrons than one in the outer layer. Thus if this theory is true we should expect to find the atoms of the elements of the first group characterized by their inability to receive a double charge; this is a striking feature of the hydrogen atom. Mr. G. P. Thomson has got by the anode ray method positive ray photographs of the lines corresponding to lithium, sodium and potassium, but has not detected the existence of double charges on the atoms of any of these elements.

Thus, as far as it goes, the evidence from multiply charged atoms in the positive rays is consistent with this theory.

Let us next consider the question of negatively charged atoms; these are atoms which have received an additional electron. On this theory, however, eight is the maximum number of electrons that can be on stable equilibrium on the outer layer, hence atoms like those of neon and argon which have already eight electrons in the outer layer have no room for more electrons and hence cannot receive a negative charge; the atoms of the elements in the other groups might be expected to get negatively charged. The positive ray photographs never give any indications of the lines due to

charged part of the molecule the ejection of electrons must diminish the charge on the negatively charged atom, and thus diminish the attraction between the atoms and therefore the stability of the system. Thus the positive electrification of molecules of this type would tend to disrupt the molecule. For example, if the molecule of HCl were to possess a double charge, the chlorine atom must have lost two negative charges, it had only an excess of one to begin with, so that it would be positively charged and repel instead of attracting the hydrogen atom.

The molecules where one of the atoms can be regarded as positively, the other as negatively electrified are of the polar type discussed on page 133. There are others which have not this polar quality, and to which the preceding reasoning does not apply; it is in accordance with this that we also find a few molecules, CO is one, which occurs with double charges, among the positive rays.

We have seen that unsaturated radicles such as CH_2 , OH occur with negative charges in the positive rays; these are not found outside discharge tubes in a free state. There are other molecules, however, of which O_2 is the most conspicuous example which can exist in the free state and yet can occur with a negative charge among the positive rays. This is consistent with the theory, since in the molecule of O_2 the twelve disposable electrons are supposed to be arranged in two octets, each atom of oxygen being surrounded by an octet of electrons, the two octets are supposed to have four electrons in common, so that together they accommodate twelve electrons. If, however, the octets were placed so that they had three electrons in common they could accommodate thirteen electrons, and the molecule would then have a unit negative charge. If the octets were arranged so that they had two instead of four electrons in common they could

accommodate fourteen electrons, which would give the molecule a double negative charge. Thus we see that in certain types of molecules the electrons may readjust themselves, so as to make room for more electrons and thus enable the molecule to acquire a negative charge. This readjustment is possible for all molecules whose structural formulæ when represented by the usual chemical notation contain double bonds.

The ability of molecules to receive a negative charge is of great importance in connexion with the mobility of the ions produced in gases by the action of Röntgen-rays. These rays, when they fall on the molecules of a gas, ionize it by ejecting electrons from the molecules, thus producing in the gas electrons and positively electrified molecules. Thus the negative ions, or at any rate the great majority of them, start as electrons, and while in this state their mobility will be much greater than that of the positive ions. If the molecules of the gas are unable to receive a negative charge the electrons will remain free and the negative ions will retain their high mobility. If, on the other hand, the electrons can attach themselves to molecules, the mobility of the negative carriers will fall and will become comparable with that of the positive ones. Franck and Hertz have shown that in argon and nitrogen, whose molecules cannot receive a negative charge, the mobility of the negative ions is enormously greater than that of the positive, but that the introduction of a very small quantity of oxygen, whose molecule can receive a negative charge, reduces the mobility of the negative ion almost to that of the positive.

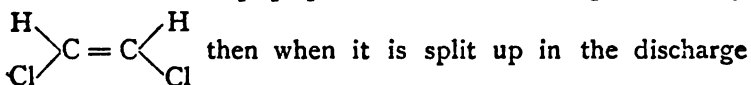
On the view we have taken of the arrangement of the electrons in the atom the valency of a charged atom should be different from that of an uncharged one. Thus, on this theory, the outer layer of the chlorine atom contains seven electrons, and as eight is the limiting number which it can

hold in stable equilibrium it cannot take an electron from more than one hydrogen atom, so that the compound HCl would be saturated. If, however, the chlorine atom were positively electrified it would have only six electrons in the outer layer, it would therefore have room for two more electrons so that the positively charged compound H_2Cl would be possible. On the other hand if the chlorine atom were negatively electrified it would have eight electrons on its outer layer and would not be able to find room for another. Again, the outer layer of an uncharged atom of oxygen contains six electrons: it can therefore accommodate the electrons from two, but not from more than two, hydrogen atoms. The positively electrified atom of oxygen has, however, only five electrons in its outer layer, and can therefore accommodate the electrons from three atoms of hydrogen forming the compound H_3O . This has the molecular weight 19, and a line corresponding to this molecular weight is very frequently found on positive ray photographs under circumstances which preclude the presence of fluorine, which would give a line in the same position.

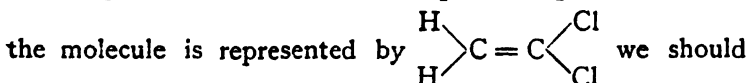
Again, we might expect that the inert gases might be able to form compounds if they were positively electrified. For a positively electrified atom of neon would only have seven electrons in the outer layer, and thus would be able to accommodate an electron from an atom of hydrogen and form the compound NeH . The compounds formed by electrified atoms of the inert gases would, I think, be an interesting subject for investigation. In this connexion it may be remarked that the helium parabola in the positive ray photographs sometimes shows an abrupt increase in intensity at a place twice as far from the vertical as the head of the parabola; showing (see p. 151) that two helium atoms have combined to form a molecule which broke up after passing through the cathode.

Another subject on which the Positive Rays may, I think,

be expected to throw light is that of the structure of the molecule. For, as we have seen, when a compound gas is in the discharge tube there are among the positive rays not only the individual atoms which went to make up the molecule, but also unsaturated combinations of these atoms, the proportions in which these combinations are present yield information about the configuration of the molecule. To illustrate this by a definite example let us take the case of $C_2H_2Cl_2$, if the molecule is represented by



vessel we should expect to get the radicle $CHCl$ in much larger quantities than either CH_2 or CCl_2 . If, however,



on the other hand expect the combinations CH_2 , CCl_2 to be more plentiful than $CHCl$. To determine questions of this kind it is necessary to use a metrical method such as that described on p. 120, which was introduced for this purpose. Investigations of this kind are now, after interruption by the war, in progress at the Cavendish Laboratory. The curves given on pp. 124, 126 illustrate the kind of information that such experiments can give. The curve for $COCl_2$, p. 127, shows that the number of its undissociated molecules in the positive rays is small compared with the number of some of its constituents such as Cl and CO , while the curve for CO , p. 124, shows that for this gas the number of undissociated molecules is very much larger than the number of any of the products of dissociation. Thus $COCl_2$ is very much more easily dissociated than CO , but the dissociation in the main consists in the tearing away of the chlorine atoms, leaving the CO intact, for we find that

the number of C or O atoms is small compared with the numbers of either CO or Cl. It is interesting to note that there are comparatively few particles of the type COCl with only one chlorine atom detached, in the great majority of cases both chlorine atoms have been removed. The chlorine atoms are thus much more easily detached from the molecule than the oxygen ones.

Investigations on the positive rays from a compound $CR_1R_2R_3R_4$, where R_1, R_2, R_3, R_4 are monovalent atoms or radicles, would enable us to compare the strengths of the bonds uniting the different radicles to the central carbon atom. Thus, for example, if R_4 were much more rigidly attached than any of the others there would be a pronounced absence of the combination $CR_1R_2R_3$ in the positive rays.

These, however, are only a few of the questions which could be attacked by this method; it gives us, for example, the means of testing whether, as is generally believed, a multiple bond between carbon atoms is an especially weak part of the molecule, for if this is so then with acetylene in the discharge tube there should be a much larger number of CH radicles in the positive rays than of either C or H. The decomposition of the molecule of an elementary gas into atoms is another problem which could be studied in this way, and it would be very interesting to see whether the proportion between the numbers of molecules and atoms of a gas in the positive rays depends upon the nature of the gas. It would seem from the curves given on pp. 124, 126, comparing those for hydrogen and oxygen with that for CO, that the proportions of molecules of undissociated CO in the positive rays to the number of atoms of O and C, which are the results of dissociation, is at any rate in some cases higher than the proportion of molecules to atoms of oxygen when the discharge passes through this gas, and thus that the

atom would be unlikely to retain in the free state the charge it possessed in the molecule.

The type of dissociation which *a priori* would be most likely to show the influence of valency is that due to collisions when one of the atoms in the molecule is hit directly by a particle of the positive rays. If the carbon atom, for example, in marsh gas suffered a direct hit by a positive-ray particle, it might acquire sufficient energy to escape from the hydrogen atoms and from the electrons which bound these to itself, it would then escape with four positive charges. The best chance of getting in the positive particles evidence of charges corresponding to the valency charges would be under conditions in which the ionization by the impact of positive rays becomes comparable with that of the ionization by electrons in the negative glow. This would be the case if we studied the nature of the particle produced in a vessel B by positive rays coming from another vessel A, the gases in A and B being different so as to prevent confusion between the primary and secondary particles.

The positive rays thus seem to promise to furnish a method of investigating the structure of the molecule, a subject certainly of no less importance than that of the structure of the atom.

PLATE I.



FIG. 1.



FIG. 2.



FIG. 3.



FIG. 4.

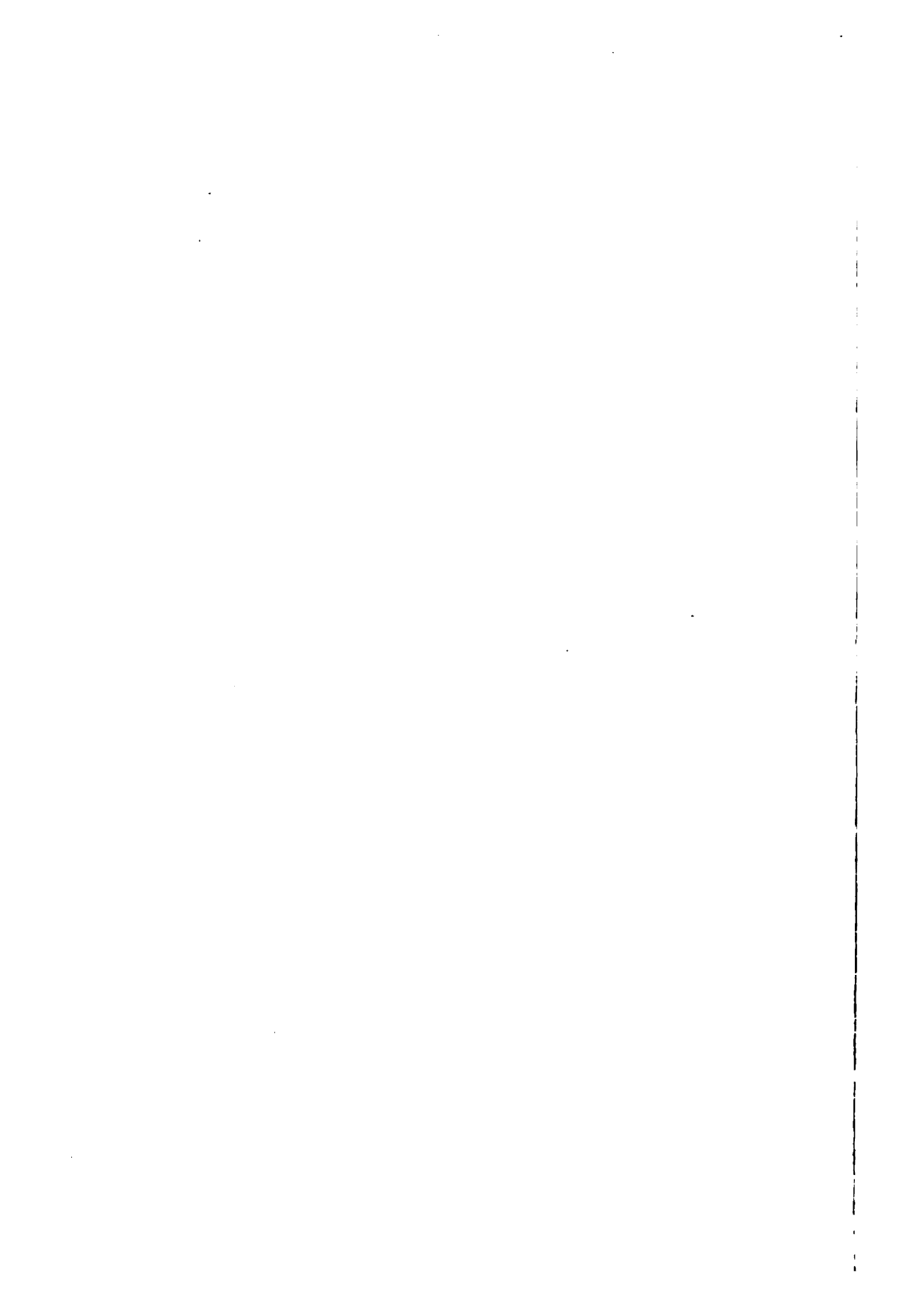


PLATE II.



FIG. 1.



FIG. 2.



FIG. 3.



FIG. 4.

PLATE III.



FIG. 1.



FIG. 2.



FIG. 3.



FIG. 4.

PLATE IV.



FIG. 1.



FIG. 2.



FIG. 3.



FIG. 4.

PLATE V.



FIG. 1.

The line corresponding to the element with atomic weight 22 can be seen just under the neon line, which is the strong line on the top at the right-hand side.

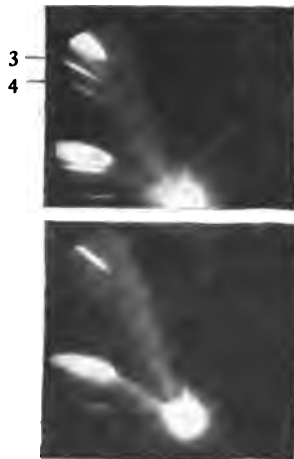


FIG. 2.

PLATE VI.



FIG. 1.



FIG. 2.



FIG. 3.



FIG. 4.

PLATE VII.



FIG. 1.

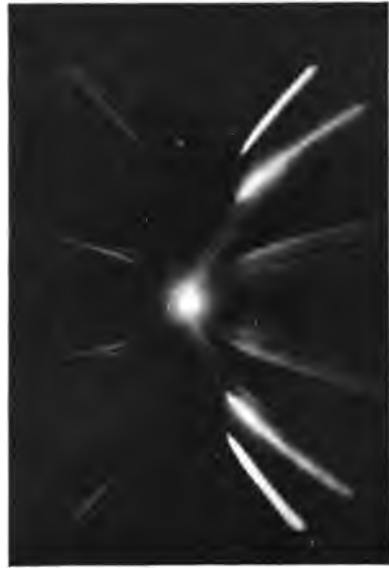


FIG. 2.



FIG. 3.

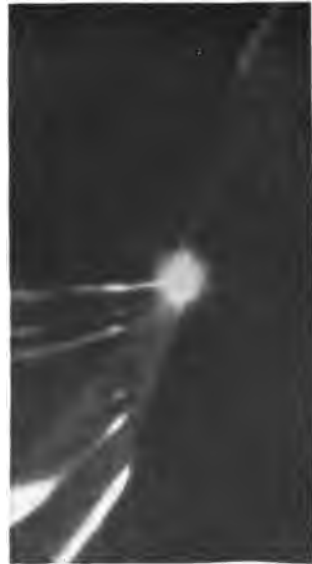


FIG. 4.



PLATE VIII.



FIG. 1.



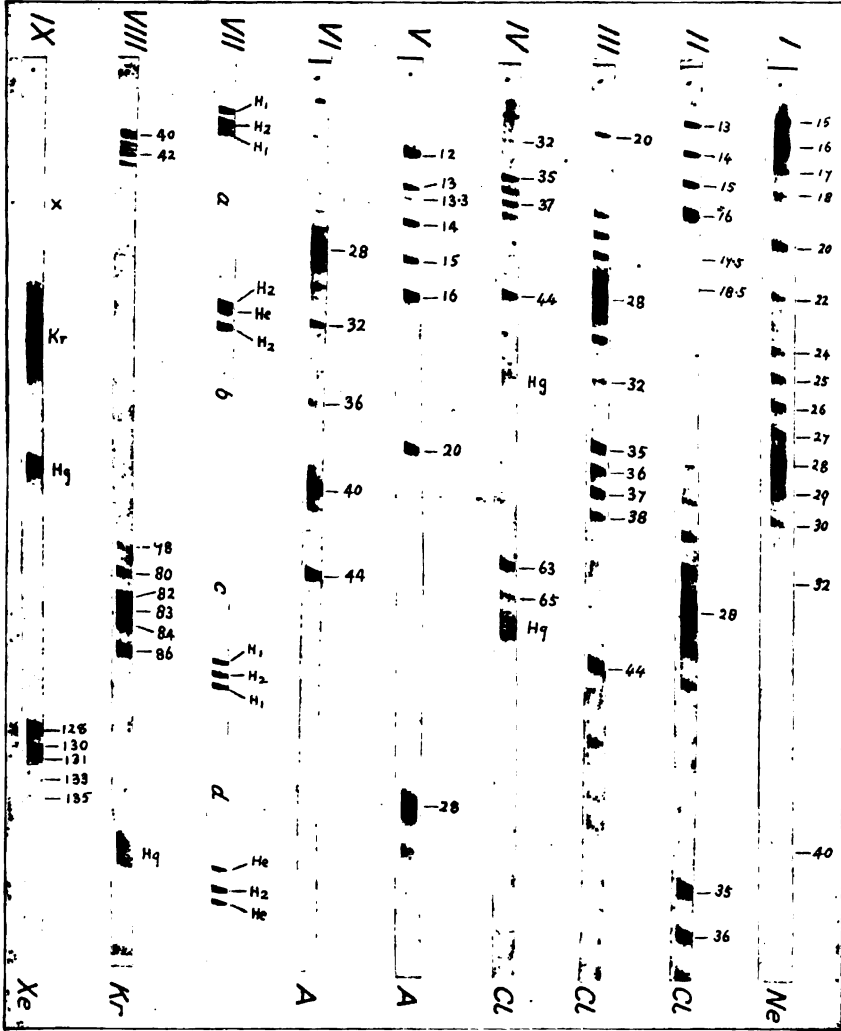
FIG. 2.

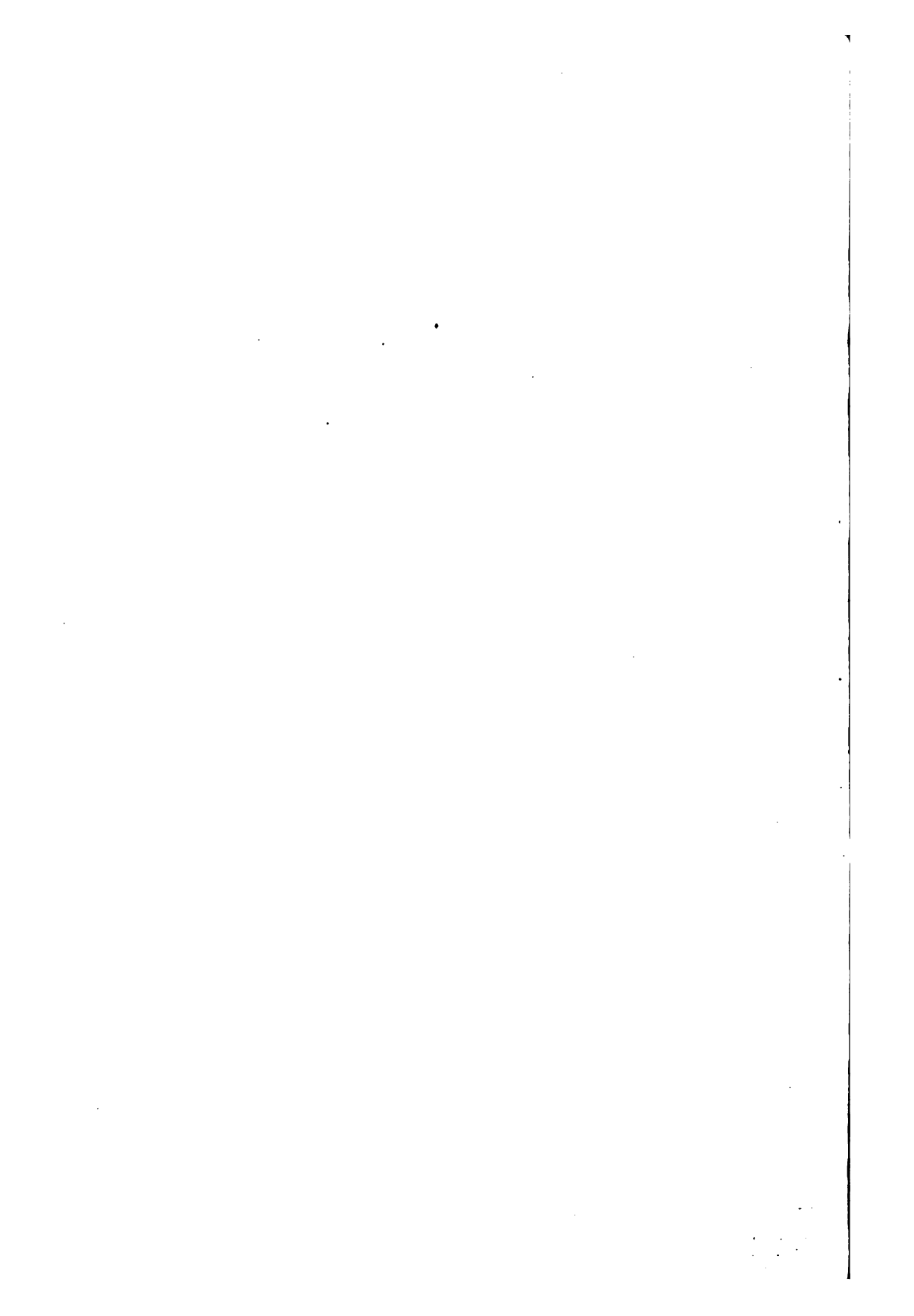


FIG. 3.



PLATE IX.





INDEX

- ABSORPTION of gases in discharge tubes, 178**
 — of positive rays, 49, 51
Analysis, chemical, by positive rays, 179
Anode rays, 134, 142
 — — analysis of, by photographic method, 147, 225
Argon, unable to receive negative charge, 76, 229
Aston, 9, 32, 36, 107, 116, 212, 213, 214, 217, 218, 220
 — and Lindeman, 213
 — and G. P. Thomson, 221
Atomic weight of beryllium, 217
 — of chlorine, 217
 — of nitrogen, 216
 — weights, determination of, by positive rays, 216
Atoms, arrangement of electrons in, 224
 — and molecules, relative brightness of lines due, 67, 88
 — multiply charged, 77, 227
 — negatively charged, 27, 70
Austin and Holborn, 173

Baedeker, 133
Baerwald, 13
v. Bahr and Franck, 58
Beading on photographs of positive rays, 63
Beryllium, atomic weight of, 217
Bibliography of Doppler effect, 169
 — of positive rays, 179
Bloch, L., 130
Bombardment by cathode rays, gases given out by, 190
 — by positive rays, spectra due to, 169
Bonds, effect of double, on negative charge, 76

Carbon monoxide, positive rays in, 124
Cathode dark space, fall of potential in, 109, 113
 — rays, 12
 — — spectra due to, 91
 — shadows on, 141
 — spluttering of, 171

Cathodes, hollow and double, 5
Chemical action, effect on ionization, 130
 — analysis by positive rays, 179
Chlorine, atomic weight of, 217
Consecutive electric and magnetic fields, 45, 117
Crookes, 9
Current carried by positive and negative particles respectively, 116

Dark space, distribution of potential in, 107, 109
 — — boundary of, 115
Davis and Horton, 14
Dechend and Hammer, 134, 178
Dempster, 36, 40, 147, 221
Dewar, 212
Disintegration of metals by positive rays, 171
 — — by radiation, 176
Doppler, bibliography of, 169
 — effect, 93, 106, 148
Double cathodes, 5, 138
Doubly charged molecules and atoms, 77, 227
Duane and Wendt, 202

Eisenmann, 113
Electrical methods of measuring positive rays, 120
Electric fields, method of consecutive, 117
Electrons, disposition of, in atom, 224
Electrostatic deflection of positive rays, 19
e/m, methods for determining, 21, 35, 36, 40, 120
Envelope of secondaries, 64

Fabry, 203
Fluorspar gives line for which $m/c = 3.5$, 203
Focus method for measuring e/m , 36
Force between positive charge and electron, 224
Franck, 76
 — and v. Bahr, 58